

SECTION 9



Cable Assemblies

**Cable Assemblies, Harnesses
and Optical Systems**

ROJONE
PTY.LTD.

Australian Representatives
ROJONE, PTY LTD.
Tel: 02 9829 1555
E: sales@rojone.com.au
www.rojone.com.au



Contents

Introduction

A Complete Offer to Cover All Environments	9-2
Worldwide Radiall Fiber Optic Presence	9-2
End-to-end Harness and Optical System Solutions	9-3
Radiall's Fiber Optic Mission	9-3

Indoor Cable Assemblies

Presentation	9-4
Components for Indoor Cable Assemblies	9-5
How to Order	9-6

Outdoor Cable Assemblies

Presentation	9-7
Components for Outdoor Cable Assemblies	9-8
How to Order	9-9
Standard Part Numbers for RXF Cable Assemblies	9-10 to 9-12
Standard Part Numbers for R2CT® Cable Assemblies	9-13
Standard Part Numbers for OSIS® Cable Assemblies	9-14 to 9-15

Harsh Environment Cable Assemblies

Presentation	9-16
Components for Harsh Environment Cable Assemblies	9-17 to 9-18
How to Order	9-19
Standard Jumpers for Harsh Environments	9-20
MT Based Cable Assemblies	9-21
EB Based Cable Assemblies	9-22

Tactical Cable Assemblies

Presentation	9-23
Components for Tactical Assemblies	9-24
How to Order	9-25
Accessories	9-26
Product Range Extension	9-26

Harnesses and Optical Systems

Presentation	9-27
Components for Harnesses and Optical Systems	9-28
Hybrid Electrical/Optical Systems	9-29
Fiber Management and Optical Solutions Layout	9-29
Accessories and Protection	9-29

Introduction

A COMPLETE OFFER TO COVER ALL ENVIRONMENTS

With 40 years of experience in fiber optics, Radiall is an expert in interconnect fiber optic systems. Radiall designs, manufactures and delivers custom cable assemblies with performances specifically adapted to meet customers' requirements and environments.



Indoor Environments

Radiall cable assemblies for indoor applications can be used in stable operational environments for temperature ranges of -20° to +70°C for Telecom applications. They provide high bandwidth, durability and are cost efficient.



Outdoor Environments

Temperature ranges for outdoor applications are typically from -40°C to +85°C. Radiall cable assemblies and harnesses for outdoor applications (ex: FTTA) feature durability and ease of integration while maintaining high optical performances.



Harsh Environments

Optical systems for harsh environments must withstand extreme temperature ranges, typically from -55°C to +125°C, and high levels of shock and vibration. They are especially dedicated to military and aerospace applications. Radiall's experience, combined with an extensive range of products developed specifically for harsh environments, allows Radiall to provide high quality cable assemblies and harnesses adapted to these environments.



Tactical Environments

Tactical cable assemblies are field deployable and operate in unstable and severe environmental conditions. Radiall provides ruggedized solutions, using tactical Expanded Beam connectors, to enable quick, reliable and easy integration for advanced communication systems in the field.



WORLDWIDE RADIALL FIBER OPTIC PRESENCE



Radiall has a global manufacturing presence. An International sales network and qualified distributors cover every region around the world. The result is quick and detailed technical support for all requests.



Characteristics and Performance

END-TO-END HARNESS AND OPTICAL SYSTEM SOLUTIONS

With an extensive product range, Radiall supports customers from the design to the production and the full industrial release of fiber optic harnesses and optical systems.

Design and Engineering

- Experienced and specialized R&D teams with more than 100 patents on optical interconnect solutions
- Dedicated design centers for design, development and prototyping
- High reactivity is made possible by close collaboration between sales, R&D and production teams

Radiall Manufacturing Capabilities

- Worldwide presence to ensure the proximity needed to provide the best quality, service and delivery performance
- Flexibility to handle high, low and mixed volumes with the same high level of quality

High-quality and Large Variety of Components

- Optical fibers and cables
- Connectors and contacts
- Cable protection and fiber management accessories

Optimized Processes

- Design, development and modeling of the optical solution
- Customer support services

Test and Quality Insurance

- Qualified test laboratories to perform product qualifications
- Radiall facilities feature state-of-the-art equipment and are all certified ISO9001-V2008 and AS9100, fully supporting the customer's quality system requirements
- Radiall optical systems are designed, manufactured and tested in accordance with all of the relevant industry standards and customers' specifications
- All measurements and quality reports can be delivered upon request



RADIALL'S FIBER OPTIC MISSION

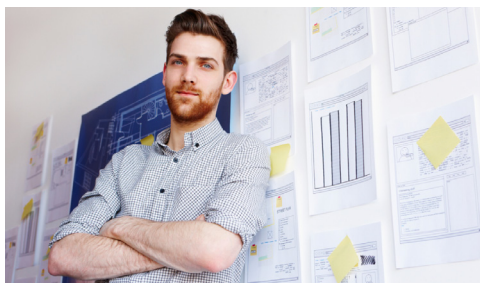

End-to-End Fiber Optic solutions for demanding applications	40 years experience in Fiber Optic	Extensive test, qualification and lean manufacturing capabilities
Constant pursue of Fiber Optic innovation		High added-value engineering
High end optical connectors and optimized accessories	Optical systems, harnesses and integrated solutions design and production	Radiall's expertise at your service through high quality product, training and support

Our Most Important Connection is with You.™

Indoor Cable Assemblies

PRESENTATION

Radiall provides optimized cable assembly solutions for indoor applications, taking into account cost, availability and performance.

Cable assemblies for indoor applications are ideal for telecom, industrial, instrumentation and medical markets. These cable assemblies are used in controlled and relatively stable environments such as wireless, FTTX, data centers, switch centers and CATV applications.

Telecom



Industrial



Medical



Instrumentation



Typical Indoor Requirements

- Operational temperature from -20°C to +70°C
- High bandwidth
- High durability (mating/unmating)
- Cost optimized

Radiall Key Factors

- Design to cost
- Mass-production capability
- High reactivity: quality in short lead time

Radiall Guarantee of Quality

- Optical measurements (IL, RL) are performed according to the IEC 61300 standards before shipment
- Visual inspection of the end face geometry to ensure the cable assembly meets the defined criteria
- Test measurement sheets with detailed reporting of the performance can be requested

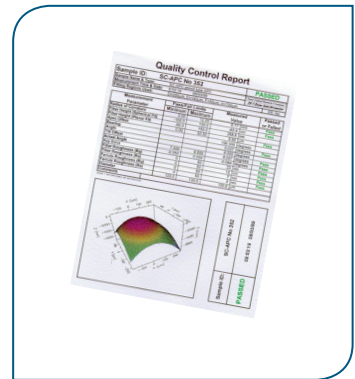

Indoor Cable Assemblies

COMPONENTS FOR INDOOR CABLE ASSEMBLIES

Typical Optical Fibers:

Radiall can accommodate various types of fiber, including the most popular fibers used for data transmission:

- SingleMode 9/125 μm
- MultiMode 50/125 μm OM2, OM3 and OM4
- MultiMode 62.5/125 μm

Typical Cables for Indoor Environments:

- Indoor cables withstand temperature ranges from -20°C to $+70^{\circ}\text{C}$
- Compliant to GR-409 Telcordia standard specifications
- Duplex, simplex and multi-fiber configurations are available
- Cable diameter from 0.9 mm to 3 mm
- Loose and tight structure cables

Radiall can work with most cables required by the customer's specific needs.

The structure of the cable is a key parameter in the choice of the connector or the contact and is usually determined by the system design. A feasibility study may be conducted to validate the selected connector/cable combination.

Polishing Processes Available:

Depending on specific requirements and application, the following polishing process may be used:

- PC: Physical Contact for MultiMode or SingleMode
- UPC: Ultra Physical Contact for MultiMode or SingleMode
- APC (8°): Angled Physical Contact for SingleMode only. For higher performance of Return Loss due to the angled end face.

Refer to Section 12, Technical Information, for more information on cable structure, polishing, testing and inspection.

TYPICAL CONNECTORS FOR INDOOR ENVIRONMENTS

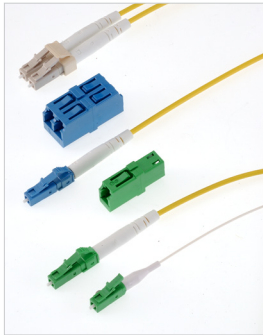

LC connectors

IEC 61754-20 standard
Radiall is an official licensee to manufacture and supply LC connectors. Available in simplex and duplex configurations.

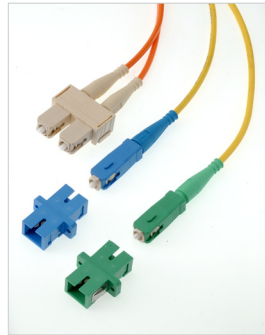

SC connectors

IEC 61754-4 standard
Available in simplex and duplex configurations.



ST connectors

IEC 61754-2 standard
Also available in sealed configurations.



FC connectors

IEC 61754-13 standard

Please refer to Section 4, LC, SC and ST Series, for more detailed information.

Radiall can produce many other connectors, contacts or fiber types. For any additional information, please contact your local Radiall representative.

Indoor Cable Assemblies

HOW TO ORDER

Radiall designs, manufactures and delivers high quality cable assemblies for indoor applications based on existing components listed above. The cable assemblies are tested for insertion loss and face visual inspection following the IEC 61300 standards.

Build-to-print:

With the build-to-print solution, Radiall complies with customer requirements, offering flexible design and manufacturing processes to build assemblies to the exact specifications. Please provide a print or requirement description to your local representative. A Technical Data Sheet will then be provided for validation.

Standard Jumper:

Using the part number builder, define the cable assembly part number by selecting the fiber optic contact and/or connector type for each end, cable type and length. Standard jumpers are considered catalog items with short lead times due to direct availability of components and established manufacturing processes.

PART NUMBER BUILDER:

LCMM 10 FCMM L100

End 1:

LCMM	LC	MultiMode	
LCSM	LC	SingleMode	UPC (RL>50dB)
LCSM8	LC	SingleMode	APC 8° (RL>65dB)
SCMM	SC	MultiMode	
SCSM	SC	SingleMode	UPC (RL>50dB)
SCSM8	SC	SingleMode	APC 8° (RL>65dB)
FCMM	FC	MultiMode	
FCSM	FC	SingleMode	UPC (RL>50dB)
FCSM8	FC	SingleMode	APC 8° (RL>65dB)
STMM	ST	MultiMode	
STSM	ST	SingleMode	UPC (RL>50dB)

Cable:

10	900 μm	MM 50/125 μm	tight	Simplex	commercial grade
11	900 μm	MM 50/125 μm	tight	Simplex	commercial grade
13	900 μm	MM 50/125 μm	loose	Simplex	commercial grade
60	900 μm	SM 9/125 μm	tight	Simplex	commercial grade
27	1.8-2 mm	MM 50/125 μm	loose	Simplex	commercial grade
39	1.8-2 mm	MM 50/125 μm	loose	Scindex	commercial grade
23	1.8-2 mm	MM 62.5/125 μm	loose	Simplex	commercial grade
40	1.8-2 mm	MM 62.5/125 μm	loose	Scindex	commercial grade
73	1.8-2 mm	SM 9/125 μm	loose	Simplex	commercial grade
77	1.8-2 mm	SM 9/125 μm	loose	Scindex	commercial grade

End 2:

See end 1

X no termination (pigtail)

Length of the cable in centimeters

Standard Length Tolerance in Centimeters	
from 12 to 100 cm	0/+2.4 cm
from 100 to 1500 cm	0/+3.4 cm
from 1500 to 3000 cm	0/+4.4 cm
from 3000 to 5000 cm	0/+17.4 cm

To validate your part number please consult your Radiall representative.

Technical datasheets are available upon request.

Outdoor Cable Assemblies

PRESENTATION

Radiall offers a wide range of cable assemblies for Telecom and Industrial applications in outdoor environments, manufacturing and delivering optimized optical link solutions in the field incorporating durability, performance, ease of integration and cost effective solutions.

Outdoor cable assemblies can sustain unstable environmental conditions and broad operating temperature ranges as in FTTX and telecom installation markets, energy distribution networks, smart grids, broadcasting, security and industrial applications.

Telecom



Industrial



Typical Outdoor Requirements

- High optical performance
- Robust connection to withstand severe external conditions such as bad weather
- Operational temperature from -40°C to +85°C.
- Less sensitivity to corrosion and pollution
- High tensile strength
- High resistance to crushes, humidity and UV radiation

Radiall Key Factors

- Proven and ruggedized high quality components
- Designed and manufactured in Radiall facilities
- Wide variety of manufacturable assemblies available
- Custom solutions for specific applications
- Mass-production capacity

Radiall Guarantee of Quality

- Optical measurements (IL, RL) are performed according to the IEC 61300 standards before shipment
- Visual inspection of the end face geometry to ensure the cable assembly meets the defined criteria
- Test measurement sheets with detailed reporting of the performance can be requested
- Radiall can conduct other tests according to specific requirements on demand

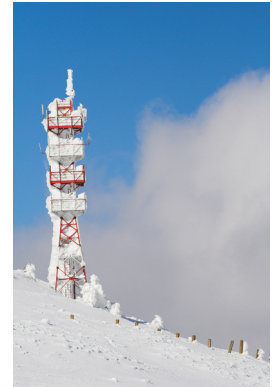

Outdoor Cable Assemblies

COMPONENTS FOR OUTDOOR CABLE ASSEMBLIES

Typical Optical Fibers:

Radiall can accommodate various types of fiber, including the most popular fibers used for data transmission:

- SingleMode 9/125 μm
- MultiMode 50/125 μm OM2, OM3 and OM4
- MultiMode 62.5/125 μm

Typical Cables for Outdoor Environments:

- Outdoor grade cable: temperature range -40°C to $+85^{\circ}\text{C}$
- Simplex, duplex and multi-fiber cables
- Tight structure cables and breakout cables

Note: Other types of cable can be used to answer to specific customer technical requirements: specific temperature range, larger diameters, armored and anti-rodent configurations, ruggedized telecom cables, etc.

For any additional information, please contact your local Radiall representative.

Polishing Processes Available:

Depending on requirements and applications the following processes may be used:

- PC: Physical Contact for MultiMode or SingleMode
- UPC: Ultra Physical Contact for SingleMode or MultiMode
- APC (8°): Angled Physical Contact for SingleMode only. For higher performance of return loss due to the angled end face.

TYPICAL CONNECTORS FOR OUTDOOR ENVIRONMENTS



RXF (2 to 6 channels)

Screwing locking device with IP68 sealing connection.

Refer to RXF connectors in Section 5 for more information.



R2CT®

Flexible waterproof connection.

Plug equipped with LC (simplex or duplex) or SC simplex.

Refer to R2CT® connectors in Section 6 for more information.



OSIS®

Quick lock push-pull and stackable connection.

Plug equipped with LC (simplex or duplex)

Refer to OSIS® connectors in Section 7 for more information.

Radiall can produce standard interface connectors such as LC, SC, FC and ST for outdoor cable assemblies.

For any additional information, please contact your local Radiall representative.

Outdoor Cable Assemblies

HOW TO ORDER

Radiall can provide custom configurations of optical cable assemblies for outdoor use based on existing components listed above. Assemblies can be customized to fit with specific application requirements such as labeling, length, etc.

All products will be manufactured in AS9100 certified assembly lines. The outdoor assemblies are visually inspected and tested per the criteria from IEC 61300 and/or the specified industry standards.

Customer Specification:

Based on cable assemblies specifications, Radiall will study and propose the best solution, providing a compliance matrix for validation.

Configure a Cable Assembly:

1. Series: RXF, R2CT®, OSIS®, LC, etc.
2. Connector end 1 + protective cap
3. Connector end 2 + protective cap
4. Fiber and cable type
5. Length (in meters or millimeters)

Radiall will provide a Technical DataSheet (TDS) for validation.

Select a Cable Assembly Among Standard Part Numbers:

Radiall designs, manufactures and supplies standard outdoor cable assemblies. A standard configuration combines standard fiber optic connectors and cables with standard length and tolerances. Standard outdoor cable assemblies are catalog items with short lead times due to the direct availability of the components.



Outdoor Cable Assemblies

STANDARD PART NUMBERS FOR RXF CABLE ASSEMBLIES

OPTICAL CHARACTERISTICS

Wave-length	1310-1550 nm
Insertion Loss	max 0.5 dB
Return Loss	>50 dB

Insertion Loss against a reference patchcord: IEC 61300-3-4 Method B
Return Loss: IEC 61300-3-6

Note: the optical performances also depend on the fiber or cable construction.
All RXF connectors in cable assemblies are provided with a dust cap (red vinyl).
All measurements and quality reports can be delivered upon request.



ENVIRONMENTAL CHARACTERISTICS

Operating Temperature Range	-40°C/+85°C
-----------------------------	-------------

R2F Socket Square Flange to LC Duplex – Indoor Simplex Cable Ø2 mm

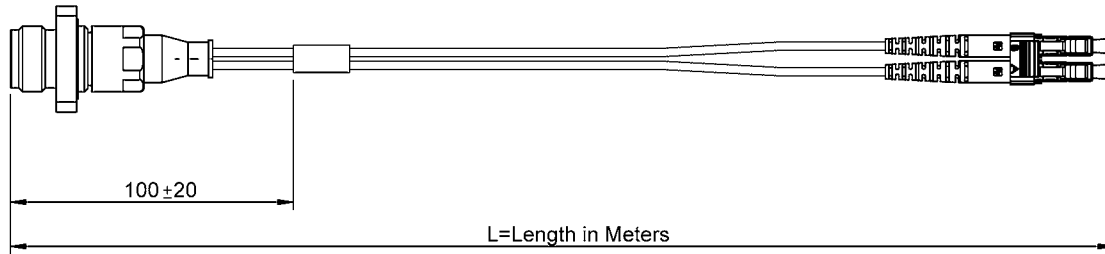

Fiber Type	Part Number	Length
SM 9/125 μm G652	F760 855 220	L=1 m
MM 50/125 μm OM2	F760 858 220	L=1 m

Note: Other lengths are available upon request.

R4F Socket Hexagonal to 2 x LC Duplex – Indoor Simplex Cable Ø2 mm

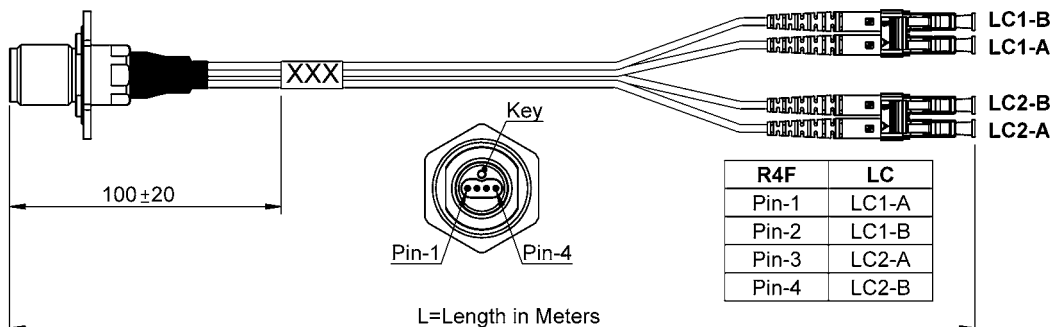

Fiber Type	Part Number	Length
SM 9/125 μm G652	F760 855 240	L=1 m
MM 50/125 μm OM2	F760 858 240	L=1 m

Note: Other lengths are available upon request.

Outdoor Cable Assemblies

R2F Plug to LC Duplex – Outdoor Field Cable Ø5 mm

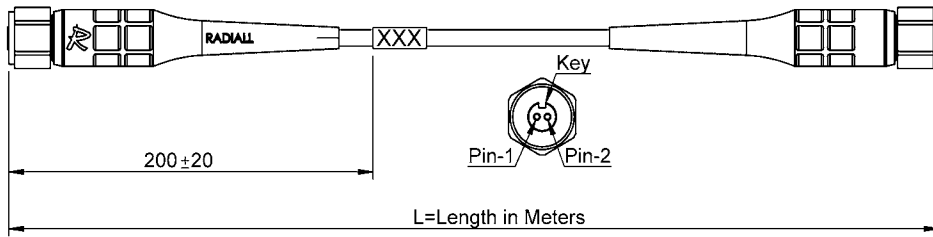

Fiber Type	Part Number (*)
SM 9/125 µm G652	F760 855 620-XX
MM 50/125 µm OM2	F760 858 620-XX

(*): replace “XX” by the length in meters

Standard length: 5 m and 50 m

Ex: F760 855 620-05 for 5 m



R2F Plug to R2F Plug – Outdoor Field Cable Ø5 mm

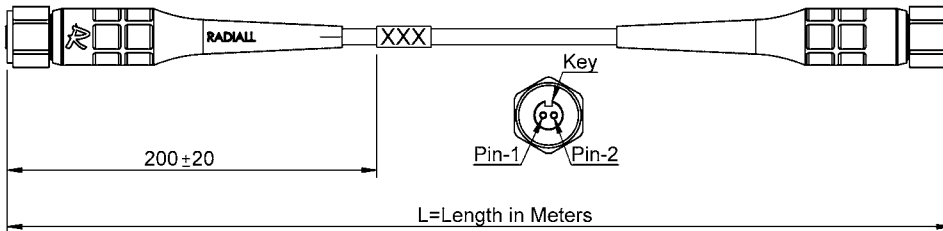

Fiber Type	Part Number (*)
SM 9/125 µm G652	F760 885 620-XX
MM 50/125 µm OM2	F760 888 620-XX

(*): replace “XX” by the length in meters

Standard length: 5 m and 50 m

Ex: F760 885 620-05 for 5 m

Outdoor Cable Assemblies

R4F Plug to 2 x LC Duplex – Outdoor Field Cable Ø5 mm

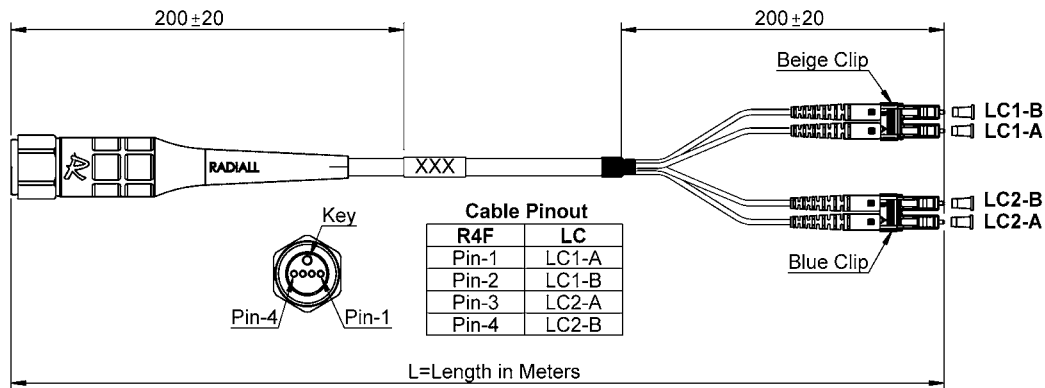

Fiber Type	Part Number (*)
SM 9/125 µm G652	F760 855 640-XX
MM 50/125 µm OM2	F760 858 640-XX

(*): replace "XX" by the length in meters

Standard length: 5 m and 50 m

Ex: F760 855 640-05 for 5 m

R4F Plug to R4F Plug – Outdoor Field Cable Ø5 mm

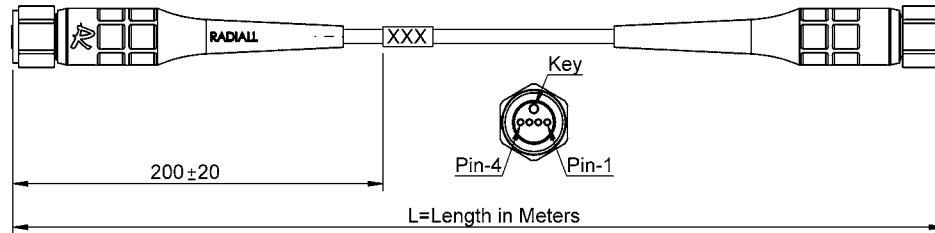

Fiber Type	Part Number (*)
SM 9/125 µm G652	F760 885 640-XX
MM 50/125 µm OM2	F760 888 640-XX

(*): replace "XX" by the length in meters

Standard length: 5 m and 50 m

Ex: F760 885 640-05 for 5 m



Outdoor Cable Assemblies

STANDARD PART NUMBERS FOR R2CT® CABLE ASSEMBLIES

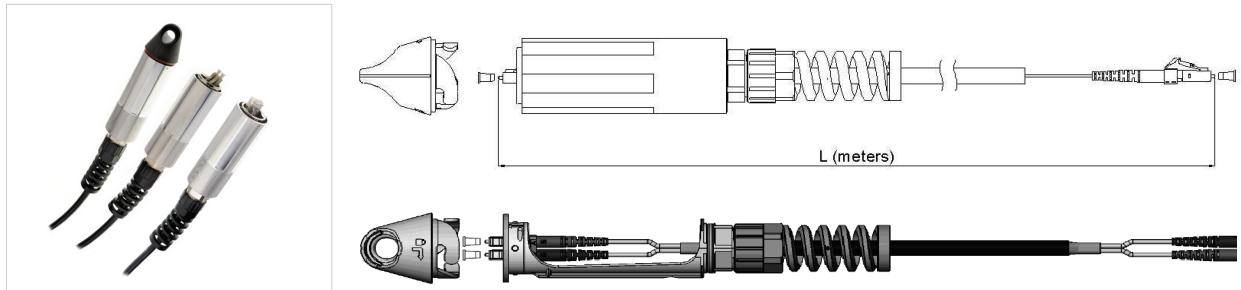

OPTICAL CHARACTERISTICS

Wave Length	1310-1550 nm
Insertion Loss	max 0.5 dB
Return Loss	>45 dB

Insertion loss against a reference patchcord: IEC 61300-3-4 Method B

Return loss: IEC 61300-3-6

Note: the optical performances also depend on the fiber or cable construction.

ENVIRONMENTAL CHARACTERISTICS

Operating Temperature Range	-40°C/+85°C
-----------------------------	-------------

R2CT® Plug to LC Duplex – Outdoor Field Cable Ø7 mm

Fiber Type	Part Number	Length
SM 9/125 µm G657a	R2CTC 855 700-01	L=1 m
SM 9/125 µm G657a	R2CTC 855 700-02	L=2 m
SM 9/125 µm G657a	R2CTC 855 700-03	L=3 m
MM 50/125 µm OM2	R2CTC 858 700-01	L=1 m
MM 50/125 µm OM2	R2CTC 858 700-02	L=2 m
MM 50/125 µm OM2	R2CTC 858 700-03	L=3 m

Note: Other lengths are available upon request.

Outdoor Cable Assemblies

STANDARD PART NUMBERS FOR OSIS® CABLE ASSEMBLIES

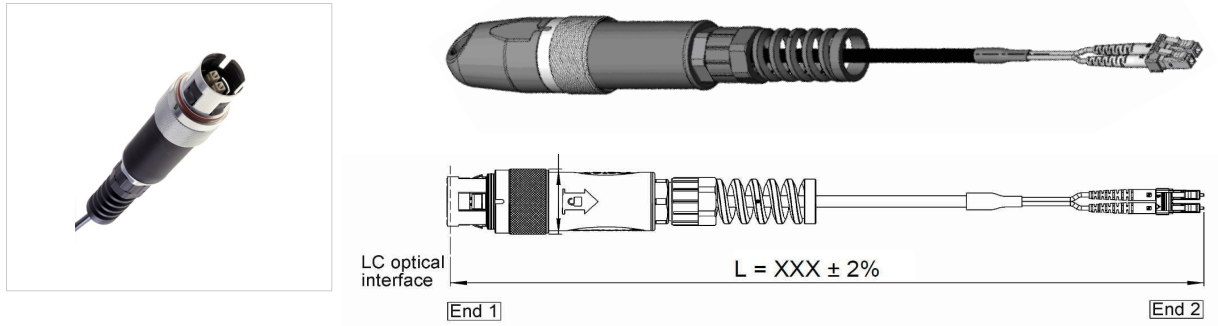

OPTICAL CHARACTERISTICS

Wave-length	1310-1550 nm
Insertion Loss	max 0.5 dB
Return Loss	>45 dB

Insertion Loss against a reference patchcord: IEC 61300-3-4 Method B

Return Loss: IEC 61300-3-6

Note: the optical performances also depend on the fiber or cable construction.

ENVIRONMENTAL CHARACTERISTICS

Operating Temperature Range	-40°C/+85°C
-----------------------------	-------------

OSIS® Plug to LC Duplex – Outdoor Field Cable Ø5 mm

Fiber Type	Part Number	Length
SM 9/125 µm G657a	OSISC 855 500-01	L=1 m
SM 9/125 µm G657a	OSISC 855 500-02	L=2 m
SM 9/125 µm G657a	OSISC 855 500-03	L=3 m
MM 50/125 µm OM2	OSISC 858 500-01	L=1 m
MM 50/125 µm OM2	OSISC 858 500-02	L=2 m
MM 50/125 µm OM2	OSISC 858 500-03	L=3 m

Note: Other lengths are available upon request.

Outdoor Cable Assemblies

STANDARD PART NUMBERS FOR LC CABLE ASSEMBLIES

LC Duplex to LC Duplex – Outdoor Field Cable Ø7 mm

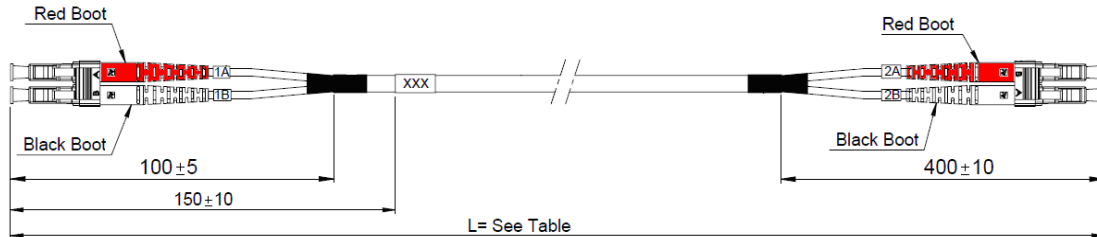

Length L (meters)

Fiber Type	Part Number (*)
SM 9/125 µm G652	F760 555 670-XXX

(*): replace “XXX” by the length in meters

Standard lengths (in meters) for SM: 1, 2, 5, 10, 15, 20, 30, 40, 50, 60, 70, 80, 90, 100, 125, 150 m

Ex: F760 555 670-005 for L=5 m

Note: Other lengths and MultiMode are available upon request.

12 LC to LC – Outdoor Field Cable Ø8 mm

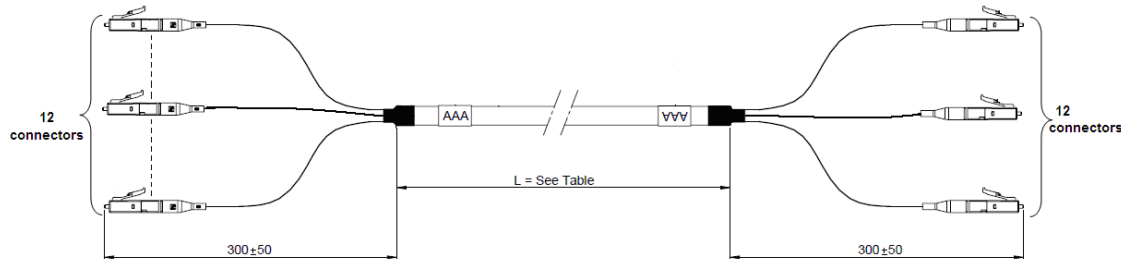

Fiber Type	Part Number (*)
SM 9/125 µm G652	F760 555 612-XXX

(*): replace “XXX” by the length in meters

Standard lengths (in meters) for SM: 5, 10, 20, 30, 40, 50, 70, 100, 200 m

Ex: F760 555 612-005 for L=5 m

Note: Other lengths and MultiMode are available upon request.



Harsh Environment Cable Assemblies

PRESENTATION

Recognized worldwide for its expertise, Radiall is a leading manufacturer of fiber optic solutions in harsh environments, chosen by major aerospace and military companies for the constant quality of products, extensive product range and reliable service. We supply our customers with high quality and high performance patchcords and harness assemblies that fulfill the demanding requirements of the aerospace and defense markets.



Harsh environment cable assemblies can withstand unstable and extreme environmental conditions as in radars, sensors, pressurized areas, avionics data transmission or In-Flight Entertainment applications and more.



Aerospace



Defense



Industrial



Typical Requirements for Harsh Environment Applications

- High optical performance
- Robust connection to withstand shocks and vibrations
- Operational temperature from -55°C to +125°C and beyond
- Lightweight and small form factor
- High density and high channel count
- Less sensitivity to corrosion, pressure and humidity

Radiall Key Factors

- Chosen manufacturer for major aerospace companies for over 10 years
- Proven, rugged and high quality components
- Expertise and support to deliver the optimal solution according to the application
- Ability to design according to customer print or from Radiall expertise
- Innovation in designing and manufacturing processes to deliver cost optimized and reliable solutions

Radiall Guarantee of Quality

- Assemblies are visually inspected and tested per the criteria from the relevant industry standards (ARINC, EN, SAE, IEC)
- All products for aerospace applications are manufactured in AS9100 certified assembly lines
- Test measurement sheets with detailed reporting of the performance can be delivered
- Radiall can conduct and supply other test data and qualification test reports to meet specific requirements

Harsh Environment Cable Assemblies

COMPONENTS FOR HARSH ENVIRONMENT CABLE ASSEMBLIES

Typical Optical Fibers:

Radiall can accommodate various types of fiber, including the most popular fibers used for data transmission:

- SingleMode 9/125 μm
- MultiMode 50/125 μm OM2, OM3 and OM4
- MultiMode 62.5/125 μm or larger core fibers

Typical Cables for Indoor Environments:

- Aerospace grade cable, loose structure, ARINC 802, temperature range (-55°C/+125°C and beyond)
- Aerospace grade cable, tight structure, ARINC 802, temperature range (-55°C/+125°C and beyond)
- Commercial grade cable "not for flight" for ground test applications
- Military cable
- Ruggedized, armored and anti-rodent telecom cable for outdoor applications
- Simplex, duplex and multi-fiber cables

Note: Standard temperatures are listed above but higher temperatures can be achieved with specific cables.

Radiall can work with most cable types required by the customer. The structure of the cable is a key parameter in the choice of the connector and/or the contact, it is usually determined by system design. A feasibility study may be conducted to validate the selected connector/cable combination.



Polishing Processes Available:

Depending on specific requirements application, the following process may be used:

- PC: Physical Contact for MultiMode or SingleMode
- UPC: Ultra Physical Contact for SingleMode or MultiMode.
- APC (8°): Angled Physical Contact for SingleMode only. For higher performance of Return Loss due to the angled end face.

Harsh Environment Cable Assemblies

TYPICAL FIBER OPTIC CONTACTS FOR HARSH ENVIRONMENTS

LuxCis® ARINC 801 contact



The LuxCis® ARINC 801 contact provides high optical performances maintained in harsh environments. It is a high density solution and is easy to use. The LuxCis® design was selected as the ARINC 801 FO interconnect solution for aerospace applications per the AEEC. It is Airbus qualified ABS1906-01 and Boeing qualified BACT64A.

MIL-PRF-29504 type termini



Designed to fit into standard electrical cavities within circular and rectangular multipin connectors. MIL-PRF-29504 type termini are described in several military standards. Radiall has developed its own design, adding improved features to this standard part.

ABS1379 contact



Radiall ABS1379 optical contact is Airbus qualified ABS1379-003 per EN 4531-101. Based on the standardized product design, Radiall has improved the sealing function and the fiber accompanying process.



Key Features & Benefits:

- Standardized contact: ARINC 801, EN4639-101 compliant, AS5590 AS5591, BACT64A, ABS1906-01
- High density with 1.25 mm ferrule
- MultiMode, SingleMode and SM APC polishing available
- Hermaphroditic contact
- Same contact fits a wide range of multipin connectors

Refer to Section 1, LuxCis® ARINC 801 Contacts, for more information.

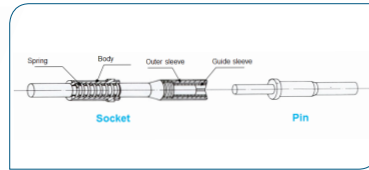

Key Features & Benefits:

- Compatible with size 16 or size 12 standard electrical cavities
- Non hermaphroditic termini
- For MultiMode fibers only
- Designed with a protected spring loaded mechanism and unique releasing boot holder

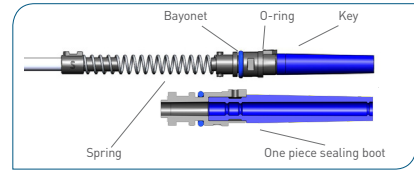

Key Features & Benefits:

- Robust construction with spring loaded butt-joint
- Standard 2.5 mm diameter ferrule
- To be used with MultiMode fibers only
- Key and bayonet systems to prevent rotation
- Integrated sealing

TYPICAL CONNECTORS FOR HARSH ENVIRONMENTS

Ruggedized LC connectors



IEC 61754-20 standard

Available in simplex and duplex configurations

Radiall is an official licensee to manufacture and supply LC connectors

Ruggedized SC connectors



IEC 61754-4 standard

Available in simplex and duplex configurations

Ruggedized FC connectors



IEC 61754-13 standard

Ruggedized ST connectors



IEC 61754-2 standard

Radiall can produce many other connectors or contacts. For any additional information, please contact your local Radiall representative.

Harsh Environment Cable Assemblies

HOW TO ORDER

Radiall designs, manufactures and delivers either build-to-print and custom cable assemblies or standard jumpers to withstand harsh environment conditions. The cable assemblies can be customized to accommodate specific requests such as labeling, lengths and packaging. All products will be manufactured in AS9100 certified assembly lines and assembly processes allow for low, high and mixed volume requirements.

Build-to-print:

With the build-to-print solution, Radiall complies with customer requirements, offering flexible design and manufacturing processes to build assemblies to the exact specifications. A Technical Data Sheet or compliance matrix will then be provided for validation.

The best adapted fiber optic interconnect solution will be used, including MT ferrules, Expanded Beam inserts and contacts.

Standard Jumpers:

Using the part number builder (see next page), define the specific cable assembly by selecting a fiber optic contact/connector for each end, cable type and length from the available choices. Standard jumpers are considered catalog items with short lead times due to direct availability of components and established manufacturing processes.

Harsh Environment Cable Assemblies

STANDARD JUMPERS FOR HARSH ENVIRONMENTS

Radiall designs, manufactures and delivers high quality cable assemblies. They are manufactured in AS9100 certified assembly lines. Each cable is visually inspected and tested before shipment.

PART NUMBER BUILDER

LUXCISMM 52 LCMM L100

End 1: ←

LUXCISMM	LuxCis®	MultiMode	
LUXCISSM	LuxCis®	SingleMode	UPC (RL>50dB)
LUXCISSM8	LuxCis®	SingleMode	APC 8° (RL>65dB)
LCMM	LC	MultiMode	
LCSM	LC	SingleMode	UPC (RL>50dB)
LCSM8	LC	SingleMode	APC 8° (RL>65dB)
SCMM	SC	MultiMode	
SCSM	SC	SingleMode	UPC (RL>50dB)
SCSM8	SC	SingleMode	APC 8° (RL>65dB)
FCMM	FC	MultiMode	
FCSM	FC	SingleMode	UPC (RL>50dB)
FCSM8	FC	SingleMode	APC 8° (RL>65dB)
STMM	ST	MultiMode	
STSM	ST	SingleMode	UPC (RL>50dB)
ABS1379MM	ABS1379	MultiMode	

Cable: ←

14	900 µm	MM 62.5/125 µm	loose	Simplex	aerospace grade
15	900 µm	MM 62.5/125 µm	tight	Simplex	aerospace grade
16	900 µm	MM 50/125 µm	loose	Simplex	aerospace grade
13	900 µm	MM 62.5/125 µm	loose	Simplex	commercial grade
11	900 µm	MM 62.5/125 µm	tight	Simplex	commercial grade
10	900 µm	MM 50/125 µm	tight	Simplex	commercial grade
60	900 µm	SM 9/125 µm	tight	Simplex	commercial grade
52	1.8-2 mm	MM 62.5/125 µm	loose	Simplex	aerospace grade
52D	1.8-2 mm	MM 62.5/125 µm	loose	Duplex	aerospace grade
53	1.8-2 mm	MM 62.5/125 µm	tight	Simplex	aerospace grade
55	1.8-2 mm	MM 50/125 µm	loose	Simplex	aerospace grade
78	1.8-2mm	MM 50/125 µm	tight	Simplex	aerospace grade
92	1.8-2 mm	SM 9/125 µm	loose	Simplex	aerospace grade
23	1.8-2 mm	MM 62.5/125 µm	loose	Simplex	commercial grade
40	1.8-2 mm	MM 62.5/125 µm	loose	Scindex	commercial grade
27	1.8-2 mm	MM 50/125 µm	loose	Simplex	commercial grade
39	1.8-2 mm	MM 50/125 µm	loose	Scindex	commercial grade
73	1.8-2 mm	SM 9/125 µm	loose	Simplex	commercial grade
77	1.8-2 mm	SM 9/125 µm	loose	Scindex	commercial grade

End2: ←

See end 1

X no termination

Length of the cable in centimeters ←

Standard Length Tolerance in Centimeters	
from 12 to 100 cm	0/+2.4 cm
from 100 to 1500 cm	0/+3.4 cm
from 1500 to 3000 cm	0/+4.4 cm
from 3000 to 5000 cm	0/+17.4 cm

To validate your part number please contact your local Radiall representative.

Technical datasheets are available upon request.

Specific requirements such as additional testing, specific labeling and additional protection of the cable can be accommodated as a custom cable assembly.

Harsh Environment Cable Assemblies

MT BASED CABLE ASSEMBLIES

Radiall is designing, manufacturing and delivering rugged cable assemblies equipped with MT ferrule interconnect solutions. Widely used in telecom and data center applications, the MT ferrule provides high density interconnection which makes it also attractive for aerospace and defense applications.

MT Ferrule Key Features and Benefits:

- High density
- Lightweight interconnection
- Physical contact termini providing low optical losses

Applications:

- Active Component interface
- Radars
- IFE (In Flight Entertainment)
- Displays

To answer customer needs for an end-to-end solution, Radiall is developing a full range of interconnect solutions around the MT ferrule in correlation with Optical Active Components. Refer to Section 10, Active Components, for more detail on emitters, receivers and transceivers product lines.

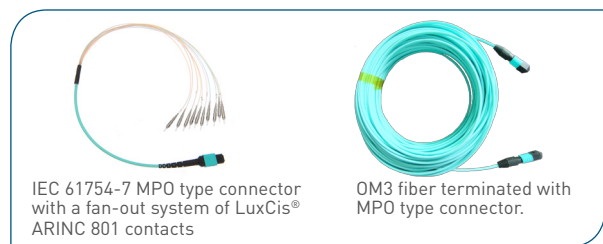
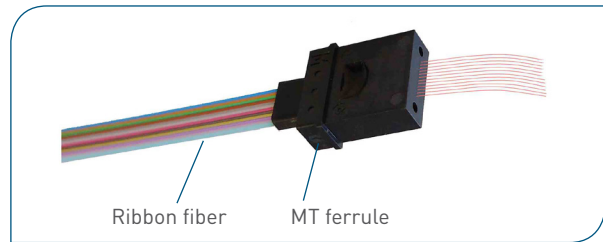

MT Fan-out Configurations:

Radiall's fan-out configuration enables transition from a high density 12 channel ribbon or round cable to singularly fanned-out round fibers, terminated with the best fitted connectors according to the application and customer needs.

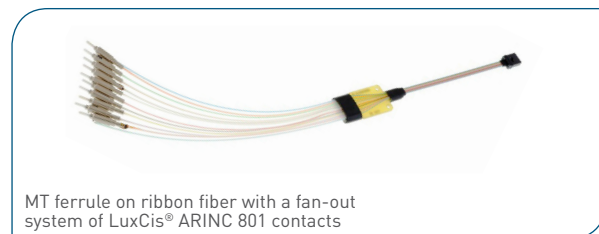

MT Interconnect Solutions:

The MT Cis, MT Cartridge Interconnect Solution, expands the range of applications of the MT ferrule in harsh environment applications.



Radiall MT-Cis protects a standard MT ferrule and enables enhanced alignment of the fibers to maintain excellent optical performance in harsh environmental and mechanical conditions. This unique design is meant to be used inside the box in mating adapters, board connectors (VITA type) or in multipin connectors.

Features:

- MT-Cis to be used in a variety of connectors and adapters
- Compatible with ribbon cords and round cables
- Easy insertion/extraction latching mechanism
- Perfectly suited to terminate pigtailed D-Light multichannel transceivers

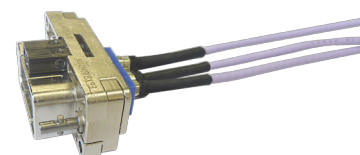

For any additional information, please contact your local Radiall representative.

Harsh Environment Cable Assemblies

EB BASED CABLE ASSEMBLIES

Radiall designs, manufactures and delivers cable assemblies with Expanded Beam interconnect solutions. The Expanded Beam offer for harsh environments includes 2 product ranges: the EB-LuxCis® product range and EB contacts interconnect solutions.

EB-LuxCis® Product Range:

The EB-LuxCis® product range combines the widely used LuxCis® ARINC 801 fiber optic contact inserted in a 2 or 4 channel (MM or SM) Expanded Beam insert, which can be used in various circular or rectangular connectors.



MIL-DTL-38999 size 11 connector



EN 4165 module

The EB-LuxCis® features a variety of multipin connectors such as MIL-DTL-38999, EN4165 modules, EPX® EN4644 and NSX ARINC 600. For any additional information, please contact your local Radiall representative.

EB Contacts for Multipin Connectors:

Radiall also provides cable assemblies with EB contacts for MIL-DTL-38999 connectors. Expanded Beam contacts fit in standard size 16 electrical cavities to incorporate EB technology in these multipin connectors.



EB contacts are also available for other multipin connectors. For any additional information, please contact your local Radiall representative.

Tactical Cable Assemblies

PRESENTATION

Radiall produces high quality tactical cable assemblies for a wide range of demanding military and harsh environment field applications.

Two main technologies exist in fiber optic connections for tactical environments: Physical Contact technology and Expanded Beam technology. Radiall will use the best of both alternatives to deliver ruggedized and field deployable cable assemblies.

Tactical cable assemblies operate in unstable and severe environmental conditions, such as in radars, military radio communication, intercom systems and many other applications.

Defense



Typical Requirements for Harsh Environment Applications

- Fast and trouble-free integration in the field
- Easy to use and trouble-free maintenance
- Extremely high mating durability
- Less sensitivity to pollution, dirt and dust
- Ruggedized connection, high resistance to crushing and shock
- High tensile strength

Radiall Key Factors

- Proven technology with high quality components for harsh environments
- Easy to integrate with hermaphroditic connections enabling blind mating and daisy chaining
- Application, environmental factors and costs are considered throughout design to provide an optimal solution
- Field support and training
- Turnkey factory assembled cable assemblies

Radiall Guarantee of Quality

- Tactical cable assemblies are visually inspected and tested per the criteria from the relevant industry standards
- We can deliver test measurement data with detailed reports on the performance of the cable assemblies
- Radiall can conduct other tests according to your requirements upon request



Tactical Cable Assemblies

COMPONENTS FOR TACTICAL CABLE ASSEMBLIES

Typical Optical Fibers:

Radiall can accommodate various types of fiber, including the most popular fibers used for data transmission:

- SingleMode 9/125 μm
- MultiMode 50/125 μm OM2, OM3 and OM4
- MultiMode 62.5/125 μm or larger core fiber

Typical Cables for Tactical Applications:

- Military tactical multi-fiber cables including anti-rodent, high crush resistance or armored cables
- Outdoor multi-fiber cables
- Various cable diameters can be accommodated

For any other requests or specific cable requirements, please contact your local Radiall representative.

Typical Connectors for Tactical Applications:

- Tactical Expanded Beam connectors (refer to Section 3, Expanded Beam Solutions, for more detail)
- LuxCis® ARINC 801 interconnect product range (refer to Sections 1 and 2 for more detail on LuxCis® ARINC 801 contact and interconnect solutions)
- Ruggedized LC, SC, ST and FC connectors (refer to Section 4 for more detail on LC, SC and ST connectors)



Radiall can produce many other connectors or contacts. Please contact Radiall for more information.

CHARACTERISTICS OF TACTICAL EXPANDED BEAM CONNECTORS

OPTICAL CHARACTERISTICS

	MultiMode PC 1300 nm	SingleMode PC 1310 nm
Insertion Loss* (typical)	0.7 dB	0.7 dB
Insertion Loss (maximum)	1.5 dB	2 dB
Return Loss**		>34 dB

*When tested with reference quality launch/receive cable assemblies

**RL tested unmated

ENVIRONMENTAL AND MECHANICAL CHARACTERISTICS

Operating Temperature Range	-40°C/+85°C
Mating Endurance	Up to 3000 mating cycles



Tactical Cable Assemblies

HOW TO ORDER

Use this configurator to define a part number for standard tactical cable assemblies using Expanded Beam Junior size tactical connectors. EB Junior size tactical connectors are designed to MIL-DTL-83526/20 & /21 mechanical interface standards.

F739 0 0 4 2 11 M 100

F739 series: EB tactical cable assembly ←

End 1: Junior size EB tactical connector ←

0: Plug
2: D-hole receptacle low profile, fan-out type for 1.6 to 1.8 mm simplex cable
3: D-hole receptacle, for 5 to 6 mm tactical cable
5: Square flange receptacle low profile, fan-out type for 1.6 to 1.8 mm simplex cable
6: Square flange receptacle, for 5 to 6 mm tactical cable

End 2: ←

0: Junior size EB plug
2: Free end
3: LC PC connector
4: LC APC connector
5: ST PC connector
6: SC PC connector
7: LuxCis® ARINC 801 APC contact
8: FC PC connector
9: LuxCis® ARINC 801 PC contact

Number of channels: 2 or 4 ←

Optimal wavelength: ←

2: SingleMode 1310 nm
3: SingleMode 1550 nm
4: MultiMode 850 nm & 1300 nm with 50/125 µm OM3 fiber
5: MultiMode 850 nm & 1300 nm with 50/125 µm fiber
6: MultiMode 850 nm & 1300 nm with 62.5/125 µm fiber

Cable type: ←

1: Multi-fiber cable, diameter 5 to 6 mm, for plug and standard receptacle
4: Multi-fiber cable, diameter 5 to 6 mm, anti-rodent with bittering agent, for plug and standard receptacle
5: Simplex fiber, diameter 1.6 to 1.8 mm for fan-out receptacle (low-profile) only
6: Multi-fiber armored cable, for plug and standard receptacle

Reel: ←

0: No cable reel (applicable for cable up to 20 m length)
1: Field deployable reel
5: Reel for backpack (applicable for cable up to 900 m cable length)
6: Disposable reel

Length unit: ←

C: Centimeter
M: Meter

Length of the cable (3 digits) ←

Each cable assembly is labeled with a heat shrink sleeve with Radiall PN and date code. For any other cable assembly configuration or specific requirements (additional testing, specific labeling, additional protection or different type of cable), please contact your local Radiall representative and a TDS for validation will be provided.

Tactical Cable Assemblies

ACCESSORIES

Radiall provides cable assemblies with various field orientated accessories such as reels and backpack reels.

Standard cable drums are available in 2 sizes:

Gantry Reel – size A

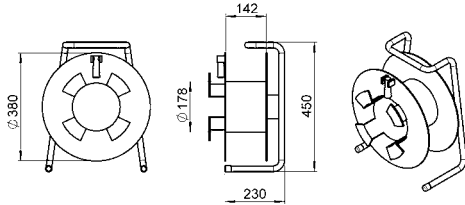

Gantry Reel – size B

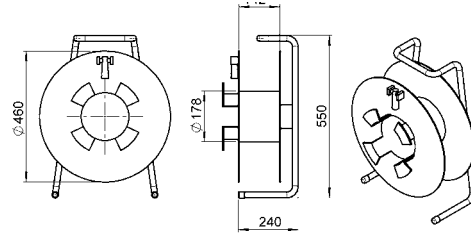

Gantry drum, with braking device and handle crank

	Size A	Size B
Color	Black	
Weight	5.90 kg	8.20 kg
Return Loss (RL)	Up to 280 m (with a 6 mm cable)	Up to 450 m (with a 6 mm cable)



RANGE EXTENSION

Not all accessories are displayed in this catalog.

Radiall is also designing other Expanded Beam solutions that provide:

- Smaller size with the mini insert (shrunken version of the Junior insert)
- More channels
- Hybrid configurations
- Environment specific designs

For any additional information, please contact your local Radiall representative.

Harnesses and Optical Systems

PRESENTATION

Radiall also manufactures high performance optical systems, boxes and complex harnesses for the various market segments. Designs are based on customer prints or designed by Radiall to meet customers' requirements and specific applications. Having 40 years of experience in fiber optic technology, Radiall's optical systems demonstrate our expertise and technical know-how. Radiall's worldwide presence and expertise has made us the supplier of choice for major companies all around the globe.



Aerospace Defense Industrial Telecom



Radiall Key Factors

Radiall provides a complete solution to address the most complex optical design requirements. From the design, materials sourcing, prototyping and full-scale production, Radiall handles it all whether it's simple point-to-point or complex multi-branch optical systems.

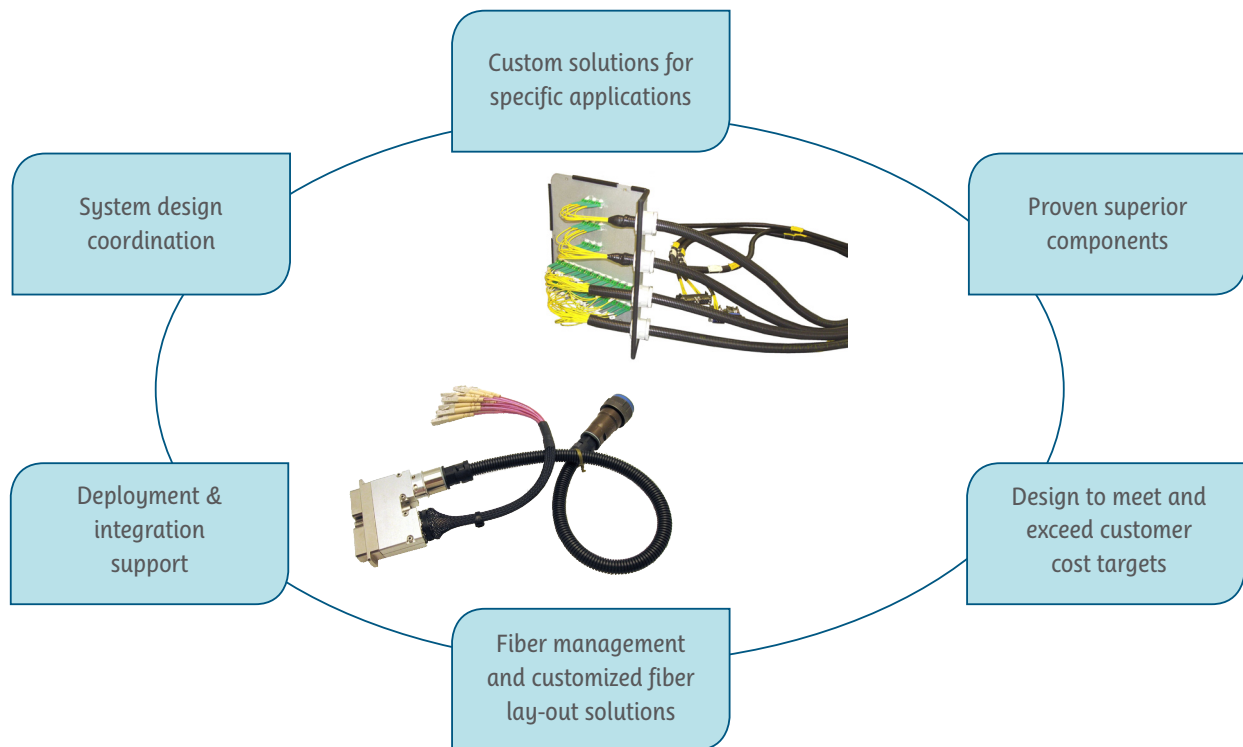

Radiall Guarantee of Quality

- Optical systems are visually inspected and tested per the criteria from the relevant industry standards (ARINC, EN, SAE, IEC)
- All products are manufactured in AS9100 certified assembly lines
- Radiall can deliver test measurement data with detailed reports on the performances of the cable assemblies
- Radiall can conduct other tests according to requirements upon request

Harnesses and Optical Systems

COMPONENTS FOR HARNESSES AND OPTICAL SYSTEMS

Typical Optical Fibers:

Radiall can accommodate various types of fiber, including the most popular fibers used for data transmission:

- SingleMode 9/125 μm
- MultiMode 50/125 μm OM2, OM3 and OM4
- MultiMode 62.5/125 μm or larger core fiber

Typical Cables for Harnesses and Optical Systems:

- Simplex, duplex and multi-fiber cables
- Loose, tight and ultra tight structure cables
- Aerospace grade cable temperature range (-55°C/+125°C)
- Ruggedized telecom cables for outdoor applications

Note: Standard temperatures are listed above but higher temperatures can be achieved with specific cables.

Polishing Processes Available:

Depending on the customer's needs and according to the application, the following process can be used:

- PC: Physical Contact for MultiMode or SingleMode connection
- UPC: Ultra Physical Contact for SingleMode or MultiMode
- APC (8°): Angled Physical Contact for SingleMode. For higher performance of Return Loss due to the angled end face.

TYPICAL CONNECTORS FOR HARNESSES AND OPTICAL SYSTEMS

Circular Connectors



Single channel LxC-R® connectors



MIL-DTL-38999 type connectors

Rectangular Connectors



EPX®/EN4644 connectors

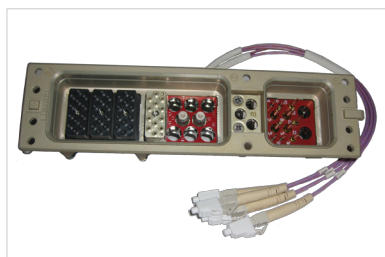

NSX/ARINC 600 connectors



DSX/ARINC 404 connectors

Radiall can produce and supply many other connectors or contacts. Please contact your local Radiall representative for more information.

Harnesses and Optical Systems

HYBRID ELECTRICAL/OPTICAL SYSTEMS

Radiall has the expertise to provide hybrid solutions for harsh environments. The use of hybrid components can reduce the overall system size and complexity. Knowledge of both technologies allows Radiall to offer customers electrical/optical systems.

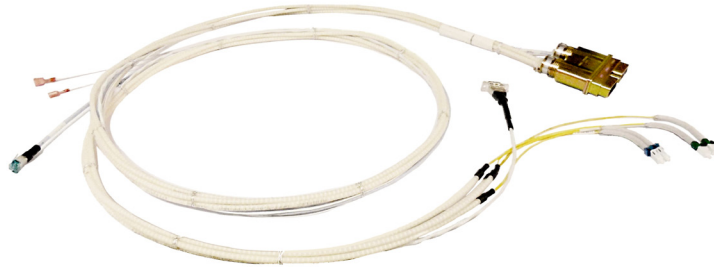

Electrical/optical systems combining EPX® connectors, LuxCis® ARINC 801 contacts, LC connectors and electrical components



EPX® connector with mixed electrical and LuxCis® ARINC 801 optical contacts

FIBER MANAGEMENT AND OPTICAL SOLUTIONS LAYOUT

Fiber management and routing are key to an optimal optical system.

Radiall delivers the optimal solution to handle, protect and improve the performance and longevity of your system.

Radiall's dedicated engineering teams:

- Analyze the project
- Source the necessary components and materials within Radiall's extensive range of products and on the market
- Devise a complete solution to ease access, repair-ability and modularity in dense circuitry with wiring schematics, fiber protection and routing instructions

Radiall's capabilities:

- Boxes design and assembly
- Optical backplanes
- Backshell design
- Optical flexible circuits
- Tray and modules to improve fiber management

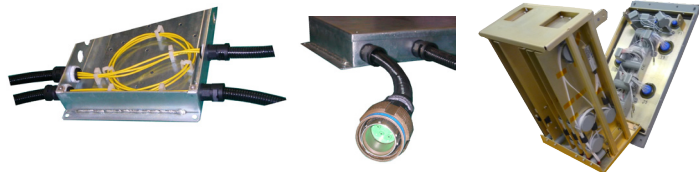

ACCESSORIES AND PROTECTION

Radiall can also provide a wide range of accessories, cable protection, backshells and customized protection.



Radiall has developed various backshells designed for Radiall rectangular and circular connectors with higher strain relief performance.



For more information about optical system configuration, please contact your local Radiall representative.

Notes
