

Pasternack

RF Product Guide 2019

Surge Protectors



Australian Representatives
ROJONE, PTY LTD.
Tel: 02 9829 1555
E: sales@rojone.com.au
www.rojone.com.au

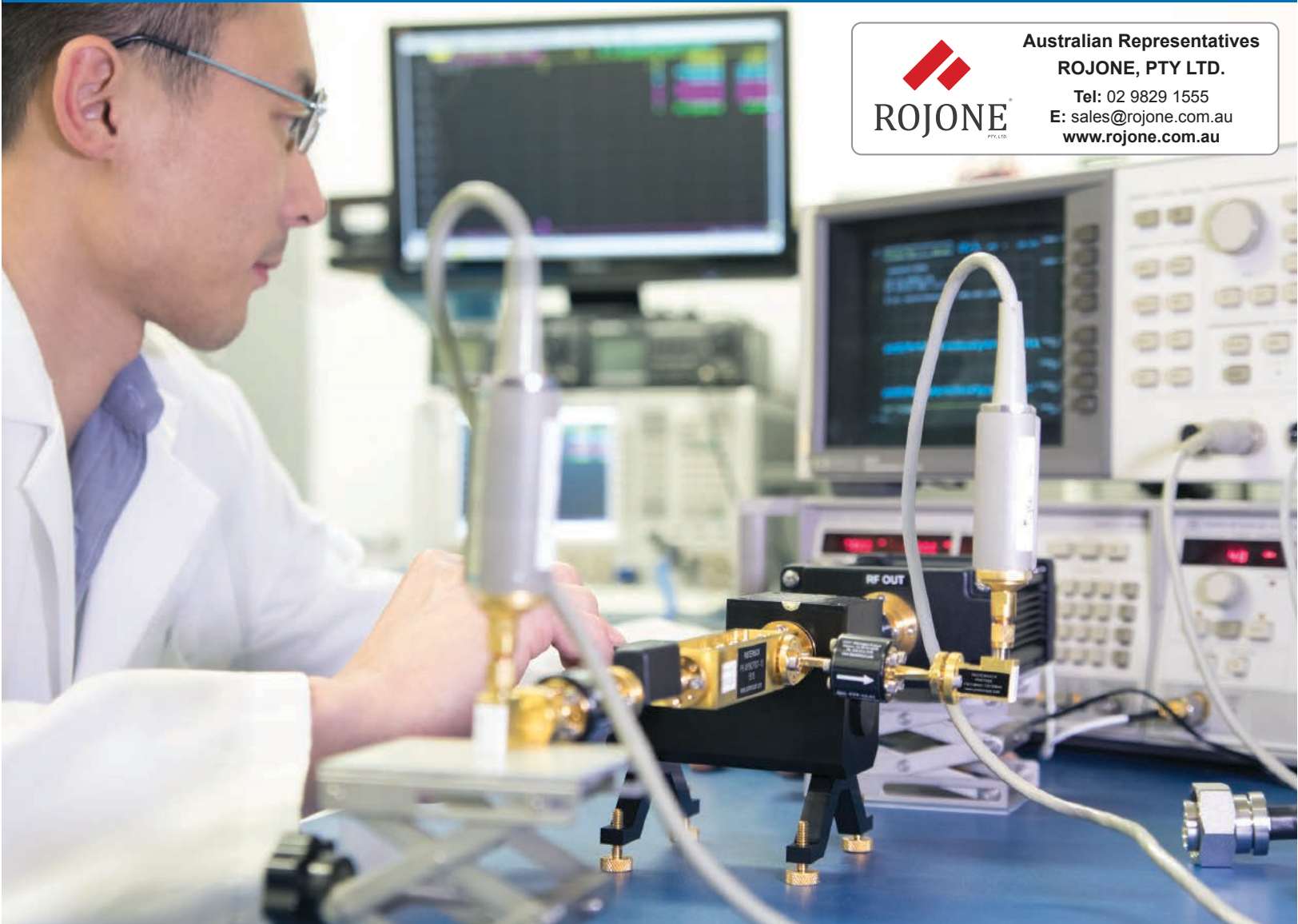

Largest Selection ✓ Same-Day Shipping ✓ Expert Technical Support ✓

866.727.8376 | sales@pasternack.com

PE PASTERNAK®
THE ENGINEER'S RF SOURCE

SURGE PROTECTORS

In Lines Surge Protectors

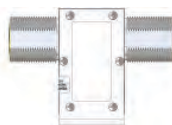
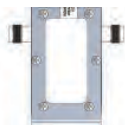

Impedance	Connector	Gender	Frequency Range (MHz.)	Mount Type	Maximum Power	Model No	1 Pc. Price	See Web for Volume Pricing	ROW		
50 Ohm	7/16 DIN	Female to Female	100 - 512	None	750 Watt	PE73SP1037	\$130.97	See Web for Volume Pricing	21		
		Female to Male	698 - 2,700	Bulkhead	1000 Watt	PE73SP1004	\$124.73		22		
					500 Watt	PE73SP1005	\$124.73		23		
			100 - 512	None	750 Watt	PE73SP1034	\$140.67		27		
					300 Watt	PE73SP1017	\$137.86		28		
		N	Female to Female	1,800 - 6,000	Bulkhead	10 Watt	PE73SP1050		\$89.10	29	
						3000 Watt	PE73SP1030		\$70.34	30	
						2000 Watt	PE73SP1025		\$58.15	31	
					100 - 512	None	750 Watt		PE73SP1033	\$98.47	32
							750 Watt		PE73SP1035	\$98.47	33
							1500 Watt		PE73SP1024	\$64.71	34
				125 - 1,000	Bulkhead	375 Watt	PE73SP1021		\$58.15	35	
	200 Watt					PE73SP1029	\$101.43		36		
	500 Watt					PE73SP1022	\$70.34		37		
	2,000 - 6,000			None	10 Watt	PE73SP1048	\$50.27		38		
					300 Watt	PE73SP1019	\$118.17		39		
					100 Watt	PE73SP1015	\$128.48		40		
					100 Watt	PE73SP1018	\$134.91		41		
					500 Watt	PE73SP1000	\$89.10		42		
					300 Watt	PE73SP1013	\$112.26		43		
	N			Female to Male	800 - 2,500	None	300 Watt		PE73SP1014	\$112.54	44
							300 Watt		PE73SP1010	\$112.54	45
							50 Watt		PE73SP1040	\$70.34	46
		DC - 2,400	Bulkhead			40 Watt	PE73SP1039		\$54.17	47	
						90 Watt	PE73SP1038		\$42.21	48	
						10 Watt	PE73SP1049		\$50.23	49	
		698 - 2,700	Bulkhead		500 Watt	PE73SP1001	\$89.10		50		
					500 Watt	PE73SP1002	\$98.47		51		
					90 Watt	PE73SP1003	\$103.40		52		
		DC - 7,000	None		90 Watt	PE73SP1041	\$44.32		53		
					750 Watt	PE73SP1036	\$98.47		54		
					375 Watt	PE73SP1028	\$64.71		55		
500 Watt	PE73SP1031			\$73.86	56						
375 Watt	PE73SP1023			\$58.15	57						
300 Watt	PE73SP1011			\$112.54	58						
N	Female to Female	800 - 2,500	None	300 Watt	PE73SP1016	\$112.54	59				
				2000 Watt	PE73SP1026	\$64.99	60				
				2000 Watt	PE73SP1032	\$67.95	61				

In-Line Surge Protectors

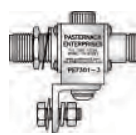

Impedance	Connector	Gender	Frequency Range (MHz.)	Mount Type	Maximum Power	Model No	1-24	25-49	50-99	100+	ROW
50 Ohm	N	Female to Female	DC - 2,500	Bulkhead	2000 Watt	PE7301-4	\$174.47	\$162.26	\$150.04	\$139.58	62
					200 Watt	PE7301-3	\$166.31	\$154.67	\$143.03	\$133.05	63
			DC - 3,000	None	2000 Watt	PE7301-1	\$155.69	\$144.79	\$133.89	\$124.55	64
					2000 Watt	PE7301-2	\$161.89	\$150.56	\$139.23	\$129.51	65

See Our Website For Current Pricing & Real-Time Stock Availability!

Surge Protectors



Free Shipping Available via UPS Ground to USA & Canada



Technical Support (866) 727-8376



Same-Day Shipping, Even Custom Cable Assemblies

Replacement Cartridges



Cartridge For	Maximum Power	Model No	1-24	25-49	50-99	100+	ROW
PE7301	2,000 Watt	PE7301-2000CART	\$21.45	\$19.95	\$18.45	\$17.16	66
	200 Watt	PE7301-200CART	\$21.45	\$19.95	\$18.45	\$17.16	67
PE7139 & PE7140	1,500 Watt	PE7139-CART	\$19.61	\$18.24	\$16.86	\$15.69	68

INDEX GUIDE TO SWITCHES

SWITCHES.....	184
ELECTROMECHANICAL RELAY SWITCHES.....	184
1M Life Cycles.....	184
2M Life Cycles.....	186
2.5M Life Cycles.....	188
5M Life Cycles.....	188
10M Life Cycles.....	189
Special Applications.....	189
HIGH ISOLATION SWITCHES.....	195
HIGH ISOLATION USB SWITCHES.....	194
MANUAL SWITCHES.....	190
PIN DIODE SWITCHES.....	190
SPST.....	190
SPDT.....	191
SP3T.....	192
SP4T.....	193
SP5T.....	193
SP6T.....	193
SP8T.....	194
SP12T.....	194
Transfer.....	194
SMT PACKAGED ELECTROMECHANICAL RELAY SWITCHES.....	190

Electromechanical Relay Switches

1M Life Cycles

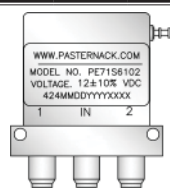

- Features:
- A: Absorptive
 - AR: Auto Reset
 - F: Failsafe
 - D: Diode
 - GR: Global Reset
 - H: Hot Switches
 - I: Indicators
 - L: Latching
 - N: Normally Open
 - NT: Non-Terminated
 - P: Pulse Latching
 - R: Reflective
 - RS: Reset
 - S: Self Cut Off
 - T: Terminated
 - TTL: TTL Logic

Max Frequency (GHz)	Switch Type	Connector Type	Features	Min Isolation (dB)	Max IL (dB)	Voltage (V)	RF Power (W CW)	Model No	1	2-4	5-9	10+	ROW
4 GHz	SPDT	N Female	F/NT	70	0.25	28	275	PE7147	\$429.00	\$403.26	\$381.81	\$364.65	1
	Transfer			PE7153				\$649.00	\$610.06	\$577.61	\$551.65	2	
10 GHz	SPDT	TNC Female		60	0.6	12	50	PE71S6198	\$885.70	\$832.56	\$788.27	\$752.85	3

PASTERNAK ENTERPRISES -- REACH PRODUCT COMPLIANCE PROGRAM

What is REACH Compliance?

Regulation (EC) No. 1907/2006 of the European Parliament and of the Council of 18 December 2006 is commonly referred to as REACH (Registration, Evaluation, Authorization, and Restriction of Chemicals). The REACH regulation became effective on June 1, 2007 to streamline and improve the former legislative framework for chemicals available in the European Union (EU) and European Economic Area (EEA) countries.

The objective of REACH is to improve protection of human health and the protection of the environment from the exposure to chemicals. REACH compliance is mandatory for products manufactured in, or imported into the European Union (EU).

As outlined by the REACH regulation, any organization manufacturing, importing, using or placing a substance, mixture, article or product on the EU market will be responsible for ensuring that the component substances are in compliance with REACH regulations.

Determining REACH Compliance of Pasternack Products:

Pasternack Enterprises does not currently either manufacture or import any chemical substances into the EU on their own or in articles (products) in quantities of 1 ton or more per year. In addition, products imported by Pasternack Enterprises' customers do not contain chemical substances intended to be released during the normal and reasonably foreseeable conditions of the product's use as defined by the REACH regulation and existing guidance.

However, under REACH, there is an obligation to ensure that articles do not contain <0.1% by weight of Substances of Very High Concern (SVHCs). SVHCs are substances that may cause cancer or other serious health or environmental effects and thus face restriction or outright bans, and are listed in a regularly-updated 'Candidate list'. The current Candidate list can be downloaded from the European Chemicals Agency (ECHA) website:

http://echa.europa.eu/chem_data/authorisation_process/candidate_list_table_en.asp

For each part that has been found to comply with the REACH SVHC reporting requirements, we show an indication of compliance adjacent to the part number using this symbol:



All products displaying this symbol on our website are assured to contain no SVHCs as defined by the Candidate List displayed on the Pasternack REACH certificate. When you locate the product you need on our website, please click on the "Product ID or Part Number". You will see the "REACH symbol" for the specific part. Click on this symbol to view the Certificate of REACH Compliance (printable if needed) for the specific product as well as the applicable ECHA SVHC Candidate list Date.

Pasternack Enterprises - REACH Product Compliance Program:

At Pasternack Enterprises, we recognize our responsibility as a worldwide supplier of RF, Microwave and Fiber Optic Products subject to the REACH regulations. We have completed a comprehensive effort internally and with our supply chain to determine the REACH compliance of our products. You will find our Reach Symbol adjacent to all products on our website that have been determined by Pasternack and our supply chain to contain less than 0.1% by weight of the REACH substances. You will also see the applicable ECHA SVHC Candidate List Date. "Please refer to our website at www.Pasternack.com.

The Pasternack Enterprises REACH Product Compliance Program is implemented in accordance with Regulation No. 1907/2006 of the European Parliament and the Council of 18 December 2006. Pasternack has implemented a REACH compliance program to address this legislation. Pasternack Enterprises does not currently either manufacture or import any chemical substances into the EU on their own or in articles (products) in quantities of 1 ton or more per year. In addition, products imported by Pasternack Enterprises' customers do not contain chemical substances intended to be released during the normal and reasonably foreseeable conditions of the product's use as defined by the REACH regulation and existing guidance. Thus, Pasternack Enterprises does not currently have a direct REACH obligation to pre-register substances. Pasternack's REACH Product Compliance is determined by a certification from our supply chain. A Pasternack product is deemed to be REACH compliant when it does not contain Substances of Very High Concern (SVHCs) beyond the specified concentration limits of less than 0.1% by weight as outlined in REACH 1907/2006/EU regulation.

Need More Information?

If you have questions regarding REACH Product Certification on Pasternack's products, please contact the Pasternack REACH Compliance Team via email at REACH@Pasternack.com or by calling Toll-Free within North America at 1-866-PASTERNAK (1-866-727-8376). International customers, please call +1-949-261-1920.



Free Shipping Available
via UPS Ground
to USA & Canada



Technical
Support
(866) 727-8376



Same-Day Shipping,
Even Custom
Cable Assemblies

PASTERNAK ENTERPRISES ROHS COMPLIANCE PROGRAM

Lead-free solder is now available for all cable assemblies upon request or online at www.Pasternack.com.

Our Commitment

At Pasternack, we recognize our responsibility as an international supplier of RF, Microwave and Millimeter wave electronics products to maintain a comprehensive RoHS compliance program. We are fully committed to offering RoHS compliance on the majority of our products and posting accurate RoHS compliance status for all of our products. We have posted this data on our website so that it can be easily found for each part number within our on-line catalogue.

What is RoHS Compliance?

The European Union set forth the RoHS (Restriction of Hazardous Substances) Directive to establish environmental guidelines and legislation to reduce the presence of six (6) materials deemed hazardous to the environment. To comply, products entering the EU must not have a homogeneous presence of these materials above the following levels by weight percentage

- Lead (Pb) < 0.1%
- Mercury (Hg) < 0.1%
- Cadmium (Cd) < 0.01%
- Hexavalent Chromium (CrVI) < 0.1%
- Polybrominated Biphenyls (PBB) < 0.1%
- Polybrominated Diphenyl Esters (PBDE) < 0.1%

Determining Pasternack RoHS Compliance

All products displaying this symbol on our website have been certified as RoHS Compliant. Click on the symbol to view the Certificate of RoHS Compliance for that product.



Lead Free Cable Assemblies

Many of Pasternack's cable assemblies are built with leaded solder. If so, the part will not be RoHS compliant and a certificate will not be found on the product page for that assembly. However, many of these assemblies can be brought into RoHS compliance through the use of Lead-Free solder. If the assembly you desire is not RoHS compliant, there may be a RoHS compliant version with a similar part number. If so, you will see an "LF" contained in the basic part number (example PE3067LF-24 is the lead free version of PE3067-24). Please note: the "LF" designation is used only when the base part number is not RoHS compliant. Many assemblies do not include "LF" and are compliant because they are only offered in a RoHS compliant configuration.

For More Information

Please direct any questions to Pasternack Enterprises Technical Support via email at TechSupport@Pasternack.com or by calling Toll-Free within North America at 1-866-PASTERNAK (866-727-8376). International customers, please use +1-949-261-1920.

MAILING LIST CHANGES

If you receive more than one RF Product Guide with the same name and address, please notify Pasternack and pass the RF Product Guide along to a friend. Also, if you do not require multiple copies to the same company address, contact a sales representative to verify and modify your mailing information. A forms-based communications method to add, delete or modify mailing information is available at www.pasternack.com. By clicking "Contact Us", and then clicking "Remove Name from Mailing List", you may complete the form to request a change to your mailing preferences. In addition, by clicking "RF Product Guide", and then clicking "Request a Printed RF Product Guide", you may add your contact information to our mailing list. Please note service opt-in and opt-out options located on the forms. Alternatively, you may mail, email, telephone or fax Pasternack your request.

PLACING YOUR ORDER

► **By Telephone: 866-PASTERNAK (866-727-8376)
US & Canada, or 949-261-1920**

Our friendly sales representatives are ready to serve you from 5:00am to 5:30pm Pacific Standard Time (PST), Monday through Friday. For the most efficient service, please have ready a list of quantities and part numbers and, if paying by credit card, your MasterCard, VISA, American Express or Discover card. Note: Calls may be recorded or monitored for quality and training purposes.

► **By Fax: 949-261-7451**

Our fax lines can be accessed 7 days a week, 24 hours a day. Orders received after 4:00pm PST will be promptly processed and shipped the next business day. Please include your daytime phone number and/or email address in case we have any questions about your order.

► **By Internet: www.Pasternack.com
or Email: sales@pasternack.com**

Order online 7 days a week, 24 hours a day using our online ordering system. Just search for the items you want and add them to your shopping cart. Internet orders entered after 4:00 pm PST will be promptly processed and shipped the next business day.

► **By Mail: Simply Mail Your Order To:
Pasternack Enterprises, Inc.
17802 Fitch
PO Box 16759
Irvine, CA 92623-6759 USA**

International customers, please see "International Orders" below for additional information.

Terms and Conditions of Sale:

The following from Pasternack's Binding Terms and Conditions of Sale are provided for your convenience. A complete documentation of the Binding Terms and Conditions of Sale may be found in the back of the RF Product Guide, or on Pasternack's website at <http://www.pasternack.com/t-terms-of-sale.aspx>. Any questions or clarifications may be answered by contacting Customer Service at (+1) 949-261-1920 or by any of the methods listed above.

No Minimum Order Requirement

Ground Freight is Free:

On UPS Ground orders, there is no charge for shipping for USA & Canada orders of \$100.00 or greater. Otherwise, shipping or freight charges and insurance will be paid by the customer. All sales are made FOB Point (as defined by the INCOTERMS 2000) in Irvine, CA USA. Shipping or freight charges from Pasternack's Irvine, CA factory are prepaid and added to the invoice or billed collect.

Same-Day Shipment:

Same-day shipment will apply to orders received Monday through Friday, prior to 4:00pm PST.

- All UPS air and surface options
- All FedEx air options (with an approved account number)
- Most other shipping options, including DHL (with an approved account number) and USPS

Counter-to-Counter Shipping:

For your urgent order requiring our fastest shipping method, we will place your order on the next available flight from Santa Ana-Orange County John Wayne International Airport (Airport code: SNA) to the destination you specify. Please call for details.

Payment Terms:

Pasternack offers a number of convenient payment methods:

For United States customers, we offer check, money order, MasterCard, VISA, American Express, Discover, and C.O.D. as well as open account credit to qualified institutions and businesses. Payment must be made in US Dollars.

For Canadian customers, we offer all of the above payment options except C.O.D.
For International customers, see **International Orders**.

Open Account Credit:

Net 30 Days terms are available to businesses, schools and agencies subject to credit approval. Approval can begin by submitting a completed Credit Application, which can be found online at:

www.Pasternack.com/t-CreditApplication.aspx

EFT/Wire Transfers:

Please contact us for details. We will inform you of the total amount which will include shipping charges and any applicable wire transfer fees. Orders will not be accepted until funds have been received in full.

WELLS FARGO BANK
420 Montgomery St.
San Francisco, CA 94104 USA
Account Number: 4270 0000 0000 0000 1
Routing Number: 121000248
SWIFT Number: WFBUS6S

International Orders:

In addition to the United States and its territories, Pasternack accepts international orders. All orders of international origin are exported from the US in accordance with the Export Administration Regulations. Diversion contrary to US Law is prohibited. Please see Pasternack's Binding Terms and Conditions of Sale for full details.

Pasternack has international distributors for the following countries:

Africa: Namibia, South Africa

Asia-Pacific: Australia, China PRC, India, Indonesia, Japan, Malaysia, New Zealand, Singapore, South Korea, Thailand

Europe: Austria, Belgium, Czech Republic, Denmark, Finland, France, Germany, Ireland, Italy, Kazakhstan, Luxembourg, Netherlands, Norway, Poland, Portugal, Russia, Slovakia, Spain, Sweden, Switzerland, Turkey, United Kingdom

Middle East: Israel

South America: Brazil

To access their complete contact information, please see our International Distributors section in this RF Product Guide. (inside back cover)

International Shipping Charges:

Shipping or freight charges and insurance will be paid by the customer. All sales are made FOB Point (as defined by the INCOTERMS 2000) in Irvine, CA USA. We ship orders by UPS, FedEx (with an approved account number), or DHL (with approved account number) with delivery in 2 to 3 days to most locations worldwide.

International Taxes and Duties:

Customer is responsible for duties and taxes.



Free Shipping Available
via UPS Ground
to USA & Canada



Technical
Support
(866) 727-8376



Same-Day Shipping,
Even Custom
Cable Assemblies

BINDING TERMS AND CONDITIONS OF SALE

The following are the terms and conditions ("Terms and Conditions") for the sale of products ("Products") by Pasternack Enterprises, Inc. ("Pasternack") to Pasternack's customers ("Customers"). Please read this agreement carefully. Any different or additional terms set forth in customer's purchase order or similar communication are objected to and shall not be binding on the company unless a separate agreement has been signed by an authorized officer of the company. By placing an order for products from the company, or by accepting delivery of the products described on the applicable packing slip, bill of lading and/or invoice received with the products, you agree to be bound by and accept these terms and conditions of sale.

1. ACCEPTANCE AND CANCELLATION OF ORDERS

All orders are subject to acceptance by Pasternack in writing by a duly authorized agent of Pasternack; any written acknowledgement of receipt of an order shall not, in and of itself, constitute such acceptance. Orders accepted and processed by Pasternack may not be cancelled by Customer except as covered by the Limited Warranty. All sales are final. Cable Assemblies and Non-Standard Products are also Non-Cancelable/Non-Refundable ("NC/NR"). Non-Standard Parts are defined as Products which are special orders, custom orders, orders for non-standard products, products not customarily in stock or orders for value-added products. In the event of cancellation or other withdrawal of an order for any reason and without limiting any other remedy which Pasternack may have as a result of such cancellation or other withdrawal, reasonable cancellation or restocking charges, which shall include all expenses then incurred and commitments made by Pasternack, shall be paid by Customer to Pasternack. Customer requests to reschedule are subject to acceptance by Pasternack in its sole discretion. Orders may not be rescheduled after the order has been submitted by Pasternack to the shipment carrier.

2. PRICES

Orders are billed at the prices (in US dollars) in effect at the time of shipment. Prices will be as specified by Pasternack and will be applicable for the period specified in Pasternack's quote. If no period is specified, quoted prices will be applicable for thirty (30) days. The website contains the most current pricing and is the price reference for orders. Pricing included in the catalog is for reference only and final pricing is determined by the published website price. Prices shown in the RF Product Guide (Catalog) and on the website are subject to change without notice. Prices are exclusive of taxes, impositions and other charges, including: sales, use, excise, value added and similar taxes or charges imposed by any government authority, international shipping charges, forwarding agent's and broker's fees, bank fees, consular fees, document fees and import duties.

3. TERMS OF PAYMENT

All payments must be in US Dollars, or will be converted to US Dollars using the available exchange rate at the time of purchase.

MasterCard, VISA, Discover, and American Express credit cards, purchase cards and major bank debit cards are accepted. Payment via net thirty (30) days is available to businesses, schools and agencies or as otherwise specified by Pasternack subject to credit approval.

For International Orders

MasterCard, VISA, and American Express credit cards are accepted. Payment via open credit account with Net thirty (30) days may be established for companies having three U.S. references accepted to Pasternack. Prepaid Wire Transfer: You can wire the funds to our bank. We will contact you with the total amount, which will include shipping charges and a \$40 wire transfer fee. Orders will not be accepted until funds have been received in full and the Purchase Order (PO) has been received. Customer is responsible for sales, use, excise, value added and similar taxes or charges imposed by any government authority, international shipping charges, forwarding agent's and broker's fees, bank fees, consular fees, document fees and import duties.

4. SALES TAX

California residents are required to remit sales tax. Pasternack does not remit sales tax to states other than California. Any sales tax due that is not collected by Pasternack is the responsibility of the customer.

5. TOLERANCES

All coaxial cable assemblies displayed in the Pasternack catalog and website have a standard cable length tolerance of $\pm 1.5\%$ or 3/8 inches (0.375"), whichever is greater. Cable Assemblies in excess of this tolerance factor are eligible for repair and/or replacement under the terms of the Pasternack Limited Warranty.

6. DELIVERY AND TITLE

Shipping or freight charges and insurance will be paid by the customer. All sales are made FCA Shipping Point (as defined by the INCOTERMS 2000) in Irvine, CA USA. Shipping or freight charges from Pasternack's Irvine, CA facility are prepaid and added to the invoice, or billed collect. Subject to Pasternack's right of stoppage in transit, delivery of the Products to the carrier will constitute delivery to Customer and title and risk of loss will pass to Customer. Pasternack will make reasonable efforts to initiate shipment and schedule delivery as close as possible to Customer's requested delivery date(s). Customer acknowledges that delivery dates provided by Pasternack are estimates only and that Pasternack will not be liable for failure to deliver on such dates. Selection of the carrier and delivery route will be made by Pasternack unless specifically designated by Customer. Pasternack reserves the right to make deliveries in installments. Delay in delivery of one installment will not entitle Customer to cancel any other installment(s). Delivery of any installment of Products within thirty (30) days after the date requested will constitute a

timely delivery. Delivery of a quantity that varies from the quantity specified shall not relieve Customer of the obligation to accept delivery and pay for the Products delivered.

7. PASTERNAK'S LIMITED WARRANTY

All products are covered by a LIMITED WARRANTY for a period of one (1) year from the date of shipment when purchased from Pasternack Enterprises, Inc. Customer must notify Pasternack within one (1) year from date of shipment of any defective product. An approved Return Material Authorization (RMA) number must first be obtained from Pasternack prior to the return of any merchandise to Pasternack for inspection under warranty. Shipping charges for all materials returned under this Limited Warranty are to be prepaid by the Customer. This warranty is limited to the original purchaser. Pasternack's liability arising out of any sale of products to Customer is expressly limited to either (1) Credit for the purchase price paid by Customer for such products (without interest), or (2) Repair and/or replacement of such products, found to be defective after inspection by Pasternack, and such remedies shall be exclusive and in lieu of all others. THIS WARRANTY IS IN LIEU OF ANY AND ALL OTHER WARRANTIES, WHETHER ORAL, WRITTEN, EXPRESSED, IMPLIED OR STATUTORY. ANY IMPLIED WARRANTIES OF MERCHANTABILITY, FITNESS FOR A PARTICULAR PURPOSE AND NON-INFRINGEMENT ARE HEREBY DISCLAIMED. Further, no warranty will apply if the Product has been subject to misuse, neglect, accident or modification, or has been soldered or altered in any way.

All returns must be shipped to: Pasternack Enterprises, Inc.
17802 Fitch
Irvine, CA 92614 USA

8. LIMITATION OF LIABILITIES

In no event shall Pasternack be liable for any special, incidental or consequential damages of any nature including, but not limited to, damages resulting from loss of profit or revenue, recall costs, claims for service interruptions or failure to supply downtime, testing, installations or removal costs, costs of substitute products, property damage, personal injury, death or legal expenses. Customer's recovery from Pasternack for any claim shall not exceed the purchase price paid by Customer for the goods, irrespective of the nature of the claim, whether in warrant, contract or otherwise. CUSTOMER SHALL INDEMNIFY, DEFEND AND HOLD PASTERNAK HARMLESS FROM ANY CLAIMS brought by any party regarding products supplied by Pasternack and incorporated into the customer's product.

9. STATEMENTS AND ADVICE

If statements or advice, technical or otherwise, are offered or given to Customer, such statements or advice will be deemed to be given as an accommodation to Customer and without charge and Pasternack shall have no responsibility or liability for the content or use of such statements or advice.

10. EXPORT CONTROL AND EMBARGOES

Products purchased or received under these Terms and Conditions are subject to export control and economic sanctions laws, restrictions, regulations and orders of the United States. Customer agrees to comply with all applicable export control laws, restrictions and regulations of the United States and shall not export, or transfer for the purpose of re-export, any product to any embargoed country or region, including but not limited to Cuba, the Crimean Region of Ukraine, Iran, North Korea, Sudan, and Syria, or to any denied, blocked, or designated person or entity as mentioned in any such United States or foreign law or regulation. Customer represents and warrants that it is not on the Denied Persons, Specially Designated Nationals or Debarred Persons List (as identified by the U.S. Treasury Office of Foreign Asset Control (OFAC) and by the U.S. Department of Commerce, Bureau of Industry and Security (BIS), or any other United States list of prohibited persons; is not owned or controlled by any person that is on one of those lists, or is otherwise prohibited by United States or other law from purchasing the products or services hereunder. Customer shall be solely responsible to obtain any license to export, re-export or import as may be required. Customer also agrees that it will not use these products in connection with the proliferation of weapons of mass destruction, including missiles, nuclear, chemical or biological weapons.

11. GENERAL

The Terms and Conditions may not be modified or cancelled without Pasternack's written agreement. Accordingly, goods furnished and services rendered by Pasternack are sold only on the terms and conditions stated herein. The Terms and Conditions will be governed by and construed in accordance with the laws of the State of California and the applicable laws of the United States of America. If Customer chooses to access the Pasternack website from outside the United States, Customer does so on their own initiative and is responsible for compliance with all applicable local laws.

12. INTELLECTUAL PROPERTY

The drawings, text, product depictions, logos, content, product descriptions, and organization and taxonomy of Pasternack's RF Product Guide and website and of the described content within the RF Product Guide and website are proprietary to Pasternack and protected by intellectual property laws, including but not limited to United States Copyright law and United States Trademark law. Pasternack owns copyrights in these referenced works as well as the selection, arrangement, coordination and structure of the arranged content and works within their RF Product Guide and website. Use of the RF Product Guide/website does not give you any right to modify, reproduce, transmit, publish, publicly display, adapt, or create derivative works or in any way exploit any of the materials and content of Pasternack's RF Product Guide or website.

WARNING: Products in this catalog can expose you to chemicals including phthalates, which are known to the State of California to cause cancer and birth defects or other reproductive harm. For more information, go to www.P65Warnings.ca.gov. For specific products impacted, please visit www.pasternack.com.

PART NUMBER INDEX

Note: C/R stands for the Column and/or Row location of the specific product on a given page.

Model No.	Page	C/R	Model No.	Page	C/R	Model No.	Page	C/R	Model No.	Page	C/R	Model No.	Page	C/R	Model No.	Page	C/R
PE6236	203	15	PE7013	58	42	PE7335	63	96	PE7S2031	193	17	PE7S6148	Web		PE7S6272	192	89
PE6238	205	38	PE7014	58	40	PE7336	63	1	PE7S2033	194	20	PE7S6149	Web		PE7S6273	192	90
PE6239	205	70	PE7015	59	49	PE7337	63	5	PE7S2034	194	25	PE7S6150	185	11	PE7S6274	192	91
PE6240	162	23	PE7016	59	50	PE7341	63	97	PE7S2035	191	44	PE7S6151	185	12	PE7S6275	192	92
PE6241	203	31	PE7017	60	58	PE7343	63	8	PE7S2036	191	42	PE7S6152	185	13	PE7S6276	192	88
PE6242	203	52	PE7018	61	69	PE7351	63	9	PE7S2037	193	94	PE7S6153	Web		PE7S6277	193	6
PE6243	203	50	PE7019	62	90	PE7356	61	66	PE7S2038	192	64	PE7S6154	185	14	PE7S6278	193	9
PE6246	204	69	PE7021	64	19	PE7357	61	71	PE7S2039	192	59	PE7S6155	185	15	PE7S6279	193	11
PE6249	204	70	PE7021	64	19	PE7362	61	71	PE7S2040	192	60	PE7S6156	Web		PE7S6280	193	13
PE6251	163	63	PE7022	65	28	PE7363	61	72	PE7S2041	191	50	PE7S6157	Web		PE7S6281	193	15
PE6800	234	23	PE7024	56	12	PE7366	60	55	PE7S2042	192	61	PE7S6158	185	16	PE7S6282	193	16
PE6801	234	29	PE7024/SP	56	13	PE7367	60	59	PE7S2043	191	41	PE7S6159	185	17	PE7S6283	193	10
PE6802	234	34	PE7025	59	45	PE7368	60	60	PE7S2044	193	93	PE7S6160	185	18	PE7S6284	193	12
PE6803	234	40	PE7026	64	17	PE7369	60	62	PE7S2045	193	18	PE7S6161	185	19	PE7S6285	193	14
PE6804	234	47	PE7027	207	6	PE7370	60	61	PE7S2046	193	19	PE7S6162	185	20	PE7S6286	193	11
PE6805	235	50	PE7028	207	11	PE7371	60	63	PE7S2047	Web		PE7S6163	Web		PE7S6287	194	27
PE6806	235	55	PE7029	67	48	PE7372	61	65	PE7S2048	Web		PE7S6164	185	21	PE7S6288	194	29
PE6807	235	61	PE7030	58	37	PE7373	60	64	PE7S3900	194	33	PE7S6165	Web		PE7S6289	194	30
PE6808	235	64	PE7031	66	40	PE7375	61	74	PE7S3901	194	34	PE7S6166	Web		PE7S6290	194	31
PE6809	234	24	PE7032	67	44	PE7378	61	75	PE7S3900	195	38	PE7S6167	Web		PE7S6291	194	32
PE6810	234	30	PE7034	69	57	PE7379	59	53	PE7S5001	195	35	PE7S6168	Web		PE7S6292	194	28
PE6811	234	35	PE7035	68	59	PE7387	60	54	PE7S5002	195	36	PE7S6169	Web	22	PE7S6293	195	36
PE6812	234	41	PE7037	68	38	PE7388	64	20	PE7S5003	195	39	PE7S6170	Web		PE7S6294	195	37
PE6813	Web		PE7040	59	44	PE7389	59	47	PE7S5004	195	40	PE7S6171	Web		PE7S6295	185	38
PE6814	235	51	PE7042	61	77	PE7387	66	34	PE7S5005	195	37	PE7S6172	185	23	PE7S6296	185	39
PE6815	235	56	PE7043	63	10	PE7388	62	86	PE7S5006	195	41	PE7S6173	Web		PE7S6297	185	40
PE6816	235	62	PE7044	67	52	PE7389	62	87	PE7S5007	189	82	PE7S6174	Web		PE7S6298	185	41
PE6817	235	65	PE7045	57	31	PE7390	58	39	PE7S5008	189	83	PE7S6175	Web		PE7S6299	185	42
PE6818	234	27	PE7046	55	1	PE7391	58	41	PE7S5009	189	84	PE7S6176	Web		PE7S6300	185	43
PE6819	234	32	PE7047	60	68	PE7392	61	67	PE7S5010	189	85	PE7S6177	Web		PE7S6301	185	44
PE6820	234	38	PE7048	59	48	PE7393	61	67	PE7S5011	189	95	PE7S6178	Web		PE7S6302	Web	
PE6821	234	43	PE7049	56	17	PE7394	62	88	PE7S5012	189	96	PE7S6179	185	24	PE7S6303	Web	
PE6823	235	53	PE7050	67	49	PE7395	56	16	PE7S5013	185	9	PE7S6180	185	25	PE7S6304	Web	
PE6824	235	59	PE7051	58	36	PE7396	67	51	PE7S5014	185	10	PE7S6181	Web		PE7S6305	185	48
PE6825	Web		PE7052	59	43	PE7403	55	2	PE7S6000	187	2	PE7S6182	Web		PE7S6306	Web	
PE6826	235	68	PE7053	59	51	PE7409	66	39	PE7S6001	Web		PE7S6183	Web		PE7S6307	Web	
PE6827	Web		PE7054	67	73	PE7410	66	41	PE7S6002	Web		PE7S6184	Web		PE7S6308	Web	
PE6828	234	33	PE7055	63	7	PE7411	66	43	PE7S6003	187	3	PE7S6185	Web		PE7S6309	186	52
PE6829	234	39	PE7057	61	50	PE7412	66	42	PE7S6004	187	36	PE7S6186	185	7	PE7S6310	Web	
PE6830	234	44	PE7061	69	64	PE7417	66	35	PE7S6005	188	40	PE7S6187	Web		PE7S6311	186	53
PE6831	234	49	PE7062	69	63	PE7418	66	36	PE7S6006	188	41	PE7S6188	Web		PE7S6312	Web	
PE6832	235	54	PE7063	69	65	PE7419	66	38	PE7S6007	188	42	PE7S6189	Web		PE7S6313	Web	
PE6833	235	60	PE7064	70	66	PE7420	66	37	PE7S6008	188	43	PE7S6190	Web		PE7S6314	Web	
PE6834	235	65	PE7066	69	20	PE7421	66	21	PE7S6009	188	44	PE7S6191	Web	5	PE7S6315	Web	
PE6835	235	69	PE7068	207	98	PE7422	70	67	PE7S6010	188	39	PE7S6192	Web		PE7S6316	Web	
PE6836	234	48	PE7068	207	1	PE7423	67	46	PE7S6011	188	45	PE7S6193	185	6	PE7S6317	Web	
PE6R000	206	92	PE7069	207	2	PE70A1000	71	29	PE7S6072	187	99	PE7S6194	Web		PE7S6318	Web	
PE6R001	207	95	PE7070	207	7	PE70A1001	68	55	PE7S6073	187	1	PE7S6195	Web		PE7S6319	Web	
PE6R002	203	43	PE7071	207	5	PE70A1008	68	56	PE7S6074	188	62	PE7S6196	Web		PE7S6320	Web	
PE6R003	206	91	PE7072	207	3	PE70A1009	56	20	PE7S6075	188	65	PE7S6197	185	8	PE7S6321	186	76
PE6R004	206	90	PE7073	207	6	PE70A1010	56	21	PE7S6076	187	4	PE7S6198	184	3	PE7S6322	186	77
PE6R005	203	35	PE7074	207	11	PE70A1011	56	22	PE7S6077	Web		PE7S6199	Web	4	PE7S6323	186	78
PE6R006	203	44	PE7075	207	14	PE70A1012	56	23	PE7S6078	Web		PE7S6200	Web		PE7S6324	186	79
PE6R007	204	64	PE7076	207	16	PE70A1013	56	24	PE7S6079	Web		PE7S6201	Web		PE7S6325	185	30
PE6R008	204	65	PE7077	207	18	PE70A1014	56	25	PE7S6080	187	24	PE7S6202	Web		PE7S6327	185	31
PE6R009	204	71	PE7078	207	20	PE70A1015	56	26	PE7S6081	Web		PE7S6203	185	26	PE7S6328	185	32
PE6R010	204	68	PE7079	207	21	PE70A1016	56	27	PE7S6082	187	98	PE7S6204	Web		PE7S6329	187	37
PE6R011	204	75	PE7081	207	22	PE70A1017	71	27	PE7S6083	187	5	PE7S6205	185	27	PE7S6330	187	38
PE6R012	204	76	PE7082	207	23	PE70A1021	68	53	PE7S6084	Web	53	PE7S6206	Web		PE7S6331	187	39
PE6R013	204	86	PE7083	207	12	PE70A1022	69	59	PE7S6085	189	81	PE7S6207	Web		PE7S6332	189	79
PE6R014	204	84	PE7085	67	45	PE70A1023	69	61	PE7S6086	Web		PE7S6208	191	52	PE7S6333	189	90
PE6R015	204	91	PE7087	58	34	PE70A1024	69	58	PE7S6087	Web		PE7S6209	190	17	PE7S6334	189	77
PE6R016	204	87	PE7088	55	4	PE70A1025	69	60	PE7S6088	189	94	PE7S6210	191	48	PE7S6335	189	86
PE6R0100	205	33	PE7089	55	3	PE70A1031	71	28	PE7S6089	Web		PE7S6211	192	76	PE7S6336	189	87
PE6R1001	205	54	PE7090	96	15	PE70A2000	71	31	PE7S6090	186	83	PE7S6212	193	96	PE7S6337	189	88
PE6R1002	206	65	PE7091	96	29	PE70A2001	71	32	PE7S6091	186	84	PE7S6213	194	21	PE7S6338	189	89
PE6R1003	206	68	PE7092	97	33	PE70A2002	71	33	PE7S6092	187	80	PE7S6214	190	18	PE7S6339	189	93
PE6R1004	206	83	PE7100	189	97	PE70A2003	71	34	PE7S6093	187	7	PE7S6215	191	49	PE7S6340	189	80
PE6R1005	206	84	PE7101	189	99	PE70A2900	71	30	PE7S6094	186	54	PE7S6216	192	77	PE7S6341	189	91
PE6R1006	206	85	PE7102	189	98	PE70A3900	71	24	PE7S6095	186	55	PE7S6217	193	97	PE7S6342	189	78
PE6R1013	204	62	PE7103	189	1	PE70A3901	71	25	PE7S6096	186	56	PE7S6218	194	22	PE7S6343	187	90
PE6R1014	203	32	PE7127	193	99	PE70A3902	71	26	PE7S6097	186	57	PE7S6219	192	69	PE7S6344	187	91
PE6R1020	205	19	PE7138	190	10	PE70A4900	70	8	PE7S6098	Web		PE7S6220	191	31	PE7S6345	186	85
PE6R1021	204	16	PE7140	188	68	PE70A5000	71	15	PE7S6099	Web	58	PE7S6221	192	78	PE7S6346	187	72
PE6R1022	204	16	PE7140	190	11	PE70A5001	71	15	PE7S6100	Web		PE7S6222	192	85	PE7S6347	187	6
PE6R1023	204	17	PE7141	185	28	PE70A5002	71	16	PE7S6101	186	59	PE7S6223	193	7	PE7S6348	187	92
PE6R1024	205	37	PE7144	185	29	PE70A5003	70	1	PE7S6102	186	65	PE7S6224	194	23	PE7S6349	188	46
PE6R1025	205	36	PE7147	184	1	PE70A5004	70	10	PE7								

PART NUMBER INDEX

Note: C/R stands for the Column and/or Row location of the specific product on a given page.

Model No.	Page	C/R	Model No.	Page	C/R	Model No.	Page	C/R	Model No.	Page	C/R	Model No.	Page	C/R	Model No.	Page	C/R
PE71S6395	188	57	PE8035	177	40	PE8551	175	21	PE831R1011	105	3	PE9087	21	A2	PE9321		Web
PE71S6396	188	58	PE8036	177	41	PE8552	175	2	PE831R1012	105	7	PE9088	37	C5	PE9322		Web
PE71S6397	187	93	PE8037	177	42	PE8553	175	4	PE831R1013	105	80	PE9089	26	A6	PE9323		Web
PE71S6398	187	94	PE8038	177	43	PE8554	175	22	PE831R1014	105	60	PE9090	25	C5	PE9324		Web
PE71S6399	188	47	PE8040	170	91	PE8700	172	18	PE831R1015	105	82	PE9091	36	A6	PE9325		Web
PE71S6400	187	28	PE8044	Web		PE8701	172	28	PE831R1016	105	62	PE9093	20	A6	PE9326		Web
PE71S6401	188	69	PE8200	Web		PE8702	172	34	PE831R1017	105	89	PE9094	Web		PE9327		Web
PE71S6402	188	70	PE8201	Web		PE8703	172	30	PE831R1018	105	66	PE9095	Web		PE9328		Web
PE71S6403	187	97	PE8203	Web	75	PE8704	172	20	PE831R1019	105	94	PE9096	Web		PE9329		Web
PE71S6404	187	13	PE8210	169	64	PE8705	172	16	PE831R1020	105	69	PE9097	37	C6	PE9330		Web
PE71S6405	188	50	PE8211	169	65	PE8706	172	17	PE831R1021	105	97	PE9098	37	B6	PE9331		Web
PE71S6406	188	59	PE8212	169	66	PE8707	172	23	PE831R1022	105	72	PE9099	37	B2	PE9332		Web
PE71S6407	188	60	PE8213	169	66	PE8708	172	25	PE831R1023	105	1	PE9100	37	D1	PE9333		Web
PE71S6408	187	17	PE8214	168	59	PE8709	172	24	PE831R1024	105	4	PE9101	24	B3	PE9334		Web
PE71S6409	187	23	PE8215	168	60	PE8710	172	22	PE831R1025	105	6	PE9102	23	D6	PE9335		Web
PE71S6410	187	29	PE8216	168	49	PE8711	172	27	PE85N1001	178	66	PE9103	28	B3	PE9336		Web
PE71S8001	186	87	PE8217	168	50	PE8712	172	29	PE85N1002	178	70	PE9104	33	C5	PE9337		26
PE71S8002	186	88	PE8218	168	51	PE8713	172	30	PE85N1003	178	71	PE9105	31	C3	PE9338		D2
PE71S8003	232	39	PE8219	169	68	PE8714	172	32	PE85N1004	178	73	PE9106	20	C6	PE9339		25
PE71S8004	232	40	PE8220	169	69	PE8715	173	53	PE85N1005	178	74	PE9107	Web		PE9340		A1
PE71S8005	232	37	PE8221	169	70	PE8716	173	52	PE85N1006	177	47	PE9108	36	B2	PE9341		Web
PE71S8006	232	38	PE8222	168	43	PE8717	173	65	PE85N1007	177	46	PE9109	Web		PE9342		Web
PE73SP1000	183	42	PE8223	168	44	PE8718	173	54	PE85N1008	177	45	PE9110	Web		PE9343		A5
PE73SP1001	183	50	PE8224	168	45	PE8719	173	58	PE85N1009	177	44	PE9111	25	B6	PE9344		Web
PE73SP1002	183	51	PE8225	168	46	PE8720	173	63	PE85N1010	178	67	PE9112	27	C1	PE9345		Web
PE73SP1003	183	52	PE8226	168	47	PE8721	173	64	PE85N1011	178	68	PE9113	Web		PE9346		29
PE73SP1004	183	22	PE8227	168	48	PE8722	173	59	PE85N1012	178	69	PE9114	Web		PE9347		C3
PE73SP1005	183	23	PE8231	168	52	PE8723	173	57	PE85N1013	178	72	PE9115	Web		PE9348		A6
PE73SP1006	183	24	PE8232	168	53	PE8724	173	60	PE85N1014	178	62	PE9116	35	B5	PE9349		27
PE73SP1007	183	25	PE8233	168	54	PE8725	173	62	PE85N1015	178	63	PE9117	Web		PE9350		Web
PE73SP1008	183	26	PE8234	169	61	PE8726	173	61	PE85N1016	178	64	PE9118	Web		PE9351		35
PE73SP1010	183	45	PE8235	Web		PE8727	173	62	PE85N1017	178	56	PE9119	Web		PE9352		B1
PE73SP1011	183	58	PE8236	169	62	PE8728	174	70	PE85N1018	178	57	PE9120	Web		PE9353		D6
PE73SP1013	183	43	PE8237	168	40	PE8729	174	71	PE85N1019	178	58	PE9121	Web		PE9354		32
PE73SP1014	183	44	PE8238	168	41	PE8730	174	72	PE85N1020	178	59	PE9122	35	D5	PE9355		Web
PE73SP1015	183	40	PE8239	168	42	PE8731	174	73	PE85N1021	178	60	PE9123	Web		PE9356		Web
PE73SP1016	183	28	PE8240	168	43	PE8732	174	74	PE85N1022	178	61	PE9124	Web		PE9357		Web
PE73SP1017	183	28	PE8241	168	44	PE8733	174	75	PE86X1000	175	10	PE9125	26	B3	PE9358		D3
PE73SP1018	183	41	PE8242	168	57	PE8734	174	76	PE86X1001	175	12	PE9126	21	A6	PE9359		Web
PE73SP1019	183	39	PE8243	179	81	PE8735	174	77	PE86X1002	175	11	PE9127	25	B1	PE9360		Web
PE73SP1021	183	35	PE8244	179	82	PE8736	174	78	PE86X1003	175	7	PE9128	24	C2	PE9361		C2
PE73SP1022	183	37	PE8245	179	83	PE8737	Web		PE86X1004	175	9	PE9129	21	D6	PE9362		C6
PE73SP1023	183	57	PE8246	179	84	PE8738	174	79	PE86X1005	175	3	PE9130	25	A5	PE9363		21
PE73SP1024	183	34	PE8247	168	45	PE8739	173	31	PE86X1006	175	6	PE9131	26	D6	PE9364		C5
PE73SP1025	183	31	PE8250	169	67	PE8740	173	33	PE86X1007	175	5	PE9132	35	C6	PE9365		22
PE73SP1026	183	60	PE8251	169	63	PE8741	172	35	PE86X1008	175	8	PE9133	Web		PE9366		Web
PE73SP1028	183	55	PE8252	169	71	PE8742	172	36	PE86X1010	175	13	PE9136	35	D6	PE9368		A5
PE73SP1029	183	36	PE8253	179	87	PE8743	173	46	PE86X9000	175	14	PE9137	35	B6	PE9369		Web
PE73SP1030	183	30	PE8254	Web		PE8744	Web		PE86X9001	175	15	PE9138	Web		PE9370		A1
PE73SP1031	183	56	PE8255	179	86	PE8747	173	50	PE86X9002	175	16	PE9139	Web		PE9371		Web
PE73SP1032	183	61	PE8300	105	78	PE8748	173	51	PE86X9003	175	17	PE9140	Web		PE9372		Web
PE73SP1033	183	27	PE8301	105	79	PE8801000	176	9	PE86X9004	175	18	PE9141	33	A2	PE9373		C4
PE73SP1034	183	33	PE8302	105	91	PE8801000	176	13	PE86X9005	175	19	PE9142	33	D6	PE9374		B1
PE73SP1035	183	33	PE8303	105	96	PE8802000	176	11	PE86X9006	175	20	PE9143	34	A1	PE9375		B5
PE73SP1036	183	54	PE8304	105	98	PE8802002	176	15	PE87FL1000	172	37	PE9144	31	B4	PE9376		A2
PE73SP1037	183	21	PE8305	105	2	PE8802003	176	16	PE87FL1001	172	38	PE9145	31	C4	PE9379		40
PE73SP1038	183	48	PE8306	105	6	PE8802004	177	19	PE87FL1002	172	40	PE9146	31	B1	PE9380		A4
PE73SP1039	183	47	PE8310	105	58	PE8802005	176	17	PE87FL1003	172	39	PE9147	Web		PE9381		Web
PE73SP1040	183	53	PE8311	105	64	PE8802006	176	18	PE87FL1004	172	41	PE9148	Web		PE9382		Web
PE73SP1041	171	13	PE8312	105	67	PE8802007	177	20	PE87FL1005	172	42	PE9149	Web		PE9383		Web
PE73SP1043	171	13	PE8313	105	70	PE8802008	177	21	PE87FL1006	173	45	PE9150	21	C1	PE9384		Web
PE73SP1044	171	14	PE8314	105	90	PE8803000	176	12	PE87FL1007	172	44	PE9151	21	B2	PE9385		Web
PE73SP1045	171	11	PE8315	105	92	PE8804000	176	14	PE87FL1008	172	43	PE9152	Web		PE9386		Web
PE73SP1046	171	12	PE8316	105	86	PE8804000	176	14	PE87FL1009	173	47	PE9153	Web		PE9387		A4
PE73SP1047	171	15	PE8317	105	86	PE8804000	176	14	PE87FL1010	173	48	PE9154	37	A3	PE9388		B3
PE73SP1048	183	40	PE8318	105	5	PE8804000	176	14	PE87FL1011	173	49	PE9155	37	C2	PE9389		A2
PE73SP1049	183	48	PE8319	105	52	PE8804000	176	14	PE87FL1012	172	19	PE9156	37	B7	PE9390		Web
PE73SP1050	183	29	PE8320	105	51	PE8804000	176	14	PE87FL1013	172	26	PE9159	Web		PE9391		Web
PE7AF1000-9	55	9	PE8321	105	73	PE8804000	176	14	PE87FL1014	173	66	PE9160	Web		PE9392		C5
PE7AF1000-20	Web		PE8322	105	53	PE8804000	176	14	PE87FL1015	174	67	PE9163	Web		PE9393		21
PE7AF1001-10	59	52	PE8323	105	74	PE8804000	176	14	PE87FL1016	174	68	PE9164	Web		PE9394		D3
PE7AF1001-21	Web		PE8324	105	54	PE8804000	176	14	PE87FL1017	174	69	PE9165	Web		PE9395		26
PE7AF1002-12	55	8	PE8325	105	76	PE8804000	176	14	PE87FL1018	173	55	PE9166	Web		PE9396		Web
PE7AF1002-20	Web		PE8326	105	56	PE8804000	176	14	PE87FL1019	173	56	PE9167	Web		PE9397		A4
PE7AF1002-30	Web		PE8327	105	87	PE8804000	176	14	PE88D2000	174	84	PE9168	Web		PE9398		26
PE7SM1000	Web		PE8328	105	95	PE8804000	176	14	PE88D2000	174	81	PE9169	Web		PE9399		D3
PE7SM1000A	190	12	PE8400	104	28	PE8804000	176	14	PE88D4000	174	82	PE9171	Web		PE9300		Web
PE8000-75	Web		PE8401	104	34	PE8804000	176	14	PE88D5000	174	80	PE9172	20	B6	PE9301		Web
PE8001	169	72	PE8402	104	38	PE8804000	176	14	PE88D8000	174	83	PE9173	24	B3	PE9302		C5
PE8001-P																	

50-OHM CONVERSION TABLE

(dBm - volts- watts)

dBm	V	Po
+53	100.0	200W
+50	70.7	100W
+49	64.0	80W
+48	58.0	64W
+47	50.0	50W
+46	44.5	40W
+45	40.0	32W
+44	32.5	25W
+43	32.0	20W
+42	28.0	16W
+41	26.2	12.5W
+40	22.5	10W
+39	20.0	8W
+38	18.0	6.4W
+37	16.0	5W
+36	14.1	4W
+35	12.5	3.2W
+34	11.5	2.5W
+33	10.0	2W
+32	9.0	1.6W
+31	8.0	1.25W
+30	7.10	1.0W
+29	6.40	800 mW
+28	5.80	640 mW
+27	5.00	500 mW
+26	4.45	400 mW
+25	4.00	320 mW
+24	3.55	250 mW
+23	3.20	200 mW
+22	2.80	160 mW
+21	2.52	125 mW
+20	2.25	100 mW
+19	2.00	80 mW
+18	1.80	64 mW
+17	1.60	50 mW
+16	1.41	40 mW
+15	1.25	32 mW
+14	1.15	25 mW
+13	1.00	20 mW
+12	0.90	16 mW
+11	0.80	12.5 mW
+10	0.71	10 mW
+9	0.64	8 mW
+8	0.58	6.4 mW
+7	0.50	5 mW
+6	0.45	4 mW
+5	0.40	3.2 mW
+4	0.36	2.5 mW
+3	0.32	2.0 mW

dBm	V	Po
+2	0.28	1.6 mW
+1	0.25	1.25 mW
0	0.23	1.0 mW
-1	0.20	.80 mW
-2	0.18	.64 mW
-3	0.16	.50 mW
-4	0.14	.40 mW
-5	0.13	.32 mW
-6	0.12	.25 mW
-7	0.10	.20 mW
-8	0.09	.16 mW
-9	0.08	.125 mW
-10	0.07	.10 mW
-11	0.06	
-12	0.06	
-13	0.05	
-14	0.05	
-15	0.04	
-16	0.0355	
dBm	mV	Po
-17	31.5	
-18	28.5	
-19	25.1	
-20	22.5	.01 mW
-21	20.0	
-22	17.9	
-23	15.9	
-24	14.1	
-25	12.8	
-26	11.5	
-27	10.0	
-28	8.9	
-29	8.0	
-30	7.1	.001 mW
-31	6.25	
-32	5.8	
-33	5.0	
-34	4.5	
-35	4.0	
-36	3.5	
-37	3.2	
-38	2.85	
-39	2.5	
-40	2.25	.1 µW
-41	2.0	
-42	1.8	
-43	1.6	
-44	1.4	
-45	1.25	

dBm	mV	Po
-46	1.18	
-47	1.0	
-48	0.9	
-49	0.8	
-50	0.71	.01 µW
-51	0.64	
-52	0.57	
-53	0.5	
-54	0.45	
-55	0.4	
-56	0.351	
-57	0.32	
-58	0.286	
-59	0.251	
-60	0.225	.001 µW
-61	0.2	
-62	0.18	
-63	0.16	
-64	0.141	
dBm	µV	Po
-65	128	
-66	115	
-67	100	
-68	90	
-69	80	
-70	71	.1 nW
-71	65	
-72	58	
-73	50	
-74	45	
-75	40	
-76	35	
-77	32	
-78	29	
-79	25	
-80	22.5	.01 nW
-81	20	
-82	18	
-83	16	
-84	11.1	
-85	12.9	
-86	11.5	
-87	10.0	
-88	9.0	
-89	8.0	
-90	7.1	.001 nW
-91	6.1	
-92	5.75	
-93	5.0	

dBm	µV	Po
-94	4.5	
-95	4.0	
-96	3.51	
-97	3.2	
-98	2.9	
-99	2.51	
-100	2.25	.1 pW
-101	2.0	
-102	1.8	
-103	1.6	
-104	1.41	
-105	1.27	
-106	1.18	
dBm	nV	Po
-107	1000	
-108	900	
-109	800	
-110	710	.01 pW
-109	640	
-112	580	
-113	500	
-114	450	
-115	400	
-116	355	
-117	825	
-118	285	
-119	251	
-120	225	.001 pW
-121	200	
-122	180	
-123	160	
-124	141	
-125	128	
-126	117	
-127	100	
-128	90	
-129	80	
-130	71	.1 fW
-131	61	
-132	58	
-133	50	
-134	45	
-135	40	
-136	35	
-137	33	
-138	29	
-139	25	
-140	23	.01 fW



Free Shipping Available
via UPS Ground to
USA & Canada



Technical
Support
(866) 727-8376



Same-Day Shipping,
Even Custom
Cable Assemblies

RETURN LOSS CONVERSION TABLE

Return Loss (dBm)	VSWR	Return Loss (dBm)	VSWR	Return Loss (dBm)	VSWR	Return Loss (dBm)	VSWR	Return Loss (dBm)	VSWR
46.064	1.01	13.842	1.51	9.485	2.01	7.327	2.51	5.999	3.01
40.086	1.02	13.708	1.52	9.428	2.02	7.294	2.52	5.970	3.02
36.607	1.03	13.577	1.53	9.372	2.03	7.262	2.53	5.956	3.03
34.151	1.04	13.449	1.54	9.317	2.04	7.230	2.54	5.935	3.04
32.256	1.05	13.324	1.55	9.262	2.05	7.198	2.55	5.914	3.05
30.714	1.06	13.201	1.56	9.208	2.06	7.167	2.56	5.893	3.06
29.417	1.07	13.081	1.57	9.155	2.07	7.135	2.57	5.872	3.07
28.299	1.08	12.964	1.58	9.103	2.08	7.105	2.58	5.852	3.08
27.318	1.09	12.849	1.59	9.051	2.09	7.074	2.59	5.832	3.09
26.444	1.10	12.736	1.60	8.999	2.10	7.044	2.60	5.811	3.10
25.658	1.11	12.625	1.61	8.949	2.11	7.014	2.61	5.791	3.11
24.943	1.12	12.518	1.62	8.899	2.12	6.984	2.62	5.771	3.12
24.289	1.13	12.412	1.63	8.849	2.13	6.954	2.63	5.751	3.13
23.686	1.14	12.308	1.64	8.800	2.14	6.925	2.64	5.732	3.14
23.127	1.15	12.207	1.65	8.752	2.15	6.896	2.65	5.712	3.15
22.607	1.16	12.107	1.66	8.705	2.16	6.867	2.66	5.693	3.16
22.120	1.17	12.009	1.67	8.657	2.17	6.839	2.67	5.674	3.17
21.664	1.18	11.913	1.68	8.611	2.18	6.811	2.68	5.654	3.18
21.234	1.19	11.818	1.69	8.565	2.19	6.783	2.69	5.635	3.19
20.828	1.20	11.725	1.70	8.519	2.20	6.755	2.70	5.617	3.20
20.443	1.21	11.634	1.71	8.474	2.21	6.728	2.71	5.598	3.21
20.079	1.22	11.545	1.72	8.430	2.22	6.700	2.72	5.579	3.22
19.732	1.23	11.457	1.73	8.386	2.23	6.673	2.73	5.561	3.23
19.401	1.24	11.370	1.74	8.342	2.24	6.646	2.74	5.542	3.24
19.085	1.25	11.285	1.75	8.299	2.25	6.620	2.75	5.524	3.25
18.783	1.26	11.202	1.76	8.257	2.26	6.594	2.76	5.506	3.26
18.493	1.27	11.120	1.77	8.215	2.27	6.567	2.77	5.488	3.27
18.216	1.28	11.039	1.78	8.173	2.28	6.541	2.78	5.470	3.28
17.949	1.29	10.960	1.79	8.138	2.29	6.516	2.79	5.452	3.29
17.690	1.30	10.881	1.80	8.091	2.30	6.490	2.80	5.435	3.30
17.445	1.31	10.804	1.81	8.051	2.31	6.465	2.81	5.417	3.31
17.207	1.32	10.729	1.82	8.011	2.32	6.440	2.82	5.400	3.32
16.977	1.33	10.654	1.83	7.972	2.33	6.415	2.83	5.383	3.33
16.755	1.34	10.581	1.84	7.933	2.34	6.390	2.84	5.365	3.34
16.540	1.35	10.509	1.85	7.894	2.35	6.366	2.85	5.348	3.35
16.332	1.36	10.437	1.86	7.856	2.36	6.341	2.86	5.331	3.36
16.131	1.37	10.367	1.87	7.818	2.37	6.317	2.87	5.315	3.37
15.936	1.38	10.298	1.88	7.781	2.38	6.293	2.88	5.298	3.38
15.747	1.39	10.230	1.89	7.744	2.39	6.270	2.89	5.281	3.39
15.563	1.40	10.163	1.90	7.707	2.40	6.246	2.90	5.265	3.40
15.385	1.41	10.097	1.91	7.671	2.41	6.223	2.91	5.248	3.41
15.211	1.42	10.032	1.92	7.635	2.42	6.200	2.92	5.232	3.42
15.043	1.43	9.968	1.93	7.599	2.43	6.177	2.93	5.216	3.43
14.879	1.44	9.904	1.94	7.564	2.44	6.154	2.94	5.200	3.44
14.719	1.45	9.842	1.95	7.529	2.45	6.131	2.95	5.184	3.45
14.564	1.46	9.780	1.96	7.494	2.46	6.109	2.96	5.168	3.46
14.412	1.47	9.720	1.97	7.460	2.47	6.086	2.97	5.152	3.47
14.264	1.48	9.660	1.98	7.426	2.48	6.064	2.98	5.137	3.48
14.120	1.49	9.601	1.99	7.393	2.49	6.042	2.99	5.121	3.49
13.979	1.50	9.542	2.00	7.360	2.50	6.021	3.00	5.105	3.50

MOUNTING HOLES

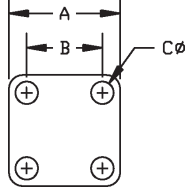

CODE	A	B	C
A01	.500	.340	.102
A02	.687	.500	.109
A03	.687	.500	#3-56 TAP
A04	.687	.500	.125
A05	1.000	.718	.125
A06	.750	.531	.140
A07	.750	.531	.125
A08	1.190	.906	.125
A09	.687	.500	#4-40 TAP
A10	.687	.500	.136
A11	1.250	.975	.147
A12	2.000	1.440	.257
A13	1.000	.718	.141
A14	1.000	.718	.144
A15	.687	.500	.104
A16	.750	.531	.136
A17	.375	.232	.067
A18	.625	.437	.094
A19	1.000	.718	#6-32 TAP
A20	.500	.340	#2-56 TAP
A21	1.250	.975	.142
A22	.375	.232	.093

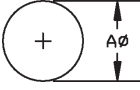

CODE	A
F01	.250
F02	.500
F03	.630
F04	1.200
F05	.380
F06	.450
F07	.200
F08	.362
F09	.220
F10	.317
F11	4.83mm
F12	.390

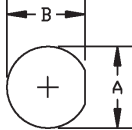

CODE	A	B
B01	.195	.177
B02	.250	.235
B03	.330	.295
B04	.380	.350
B05	.440	.410
B06	.512	.480
B07	.760	.720
B08	.565	.537
B09	.314	.296
B10	.140	.126
B11	.695	.655
B12	.625	.575
B13	.405	.361
B14	.277	.252
B15	.630	.596
B16	.317	.285
B17	.284	.268

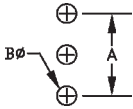

CODE	A	B
J01	.200	.046

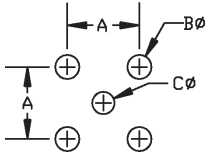

CODE	A	B	C
D01	.200	.067	.062
D02	.200	.067	.046
D03	.100	.031	.031
D04	.200	.052	.052
D05	.260	.067	.043
D06	.200	.052	.047
D07	.200	.055	.043
D08	.200	.067	.035
D09	.200	.055	.028
D10	.200	.055	.035
D11	.320	.091	.031
D12	.400	.062	.062
D13	.320	.091	.091
D14	.340	.091	.043
D15	.164	.067	.091
D16	.500	.126	.440
D17	.380	.083	.043

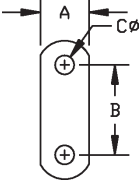

CODE	A	B	C
C01	.223	.481	.102
C02	.260	.481	.102
C03	.192	.328	.067
C04	.640	1.000	.125
C05	.275	.481	.102
C06	.230	.354	.067
C07	.188	.328	.093

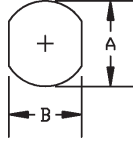

CODE	A	B
G01	.640	.546
G02	.380	.340
G03	.765	.712
G04	.362	.323
G05	.236	.197
G06	.217	.177
G07	.380	.310
G08	1.161	1.000

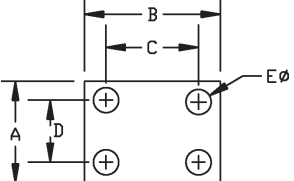

CODE	A	B	C	D	E
E01	.375	.500	.340	.222	.093

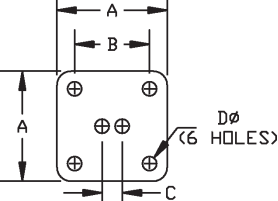

CODE	A	B	C	D
H01	.687	.500	.125	.045



Free Shipping Available
via UPS Ground to
USA & Canada



Technical
Support
(866) 727-8376



Same-Day Shipping,
Even Custom
Cable Assemblies

CONNECTOR IDENTIFIER

SPECIFICATIONS SHOWN ARE INTENDED FOR IDENTIFICATION PURPOSES ONLY

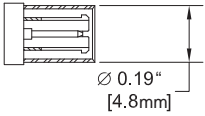
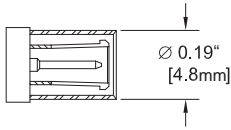
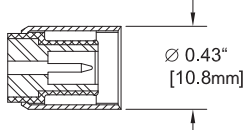
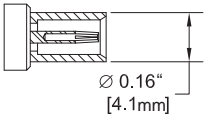
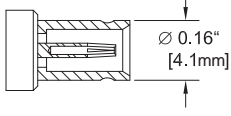
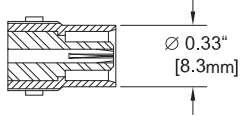
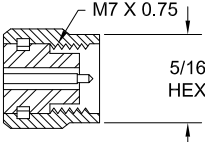
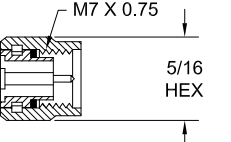
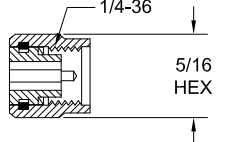
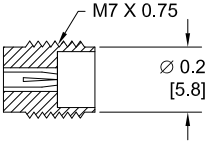
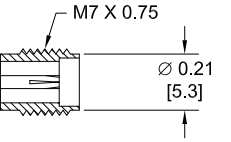
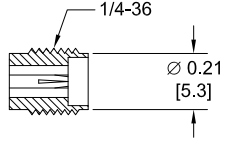
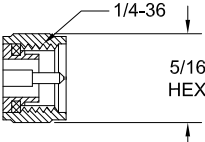
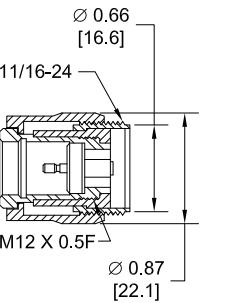
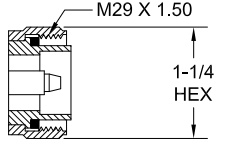
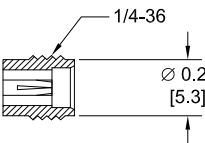
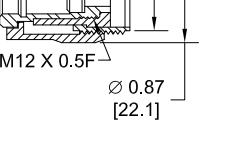
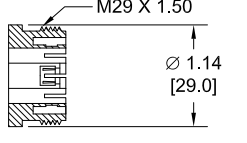
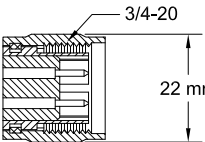
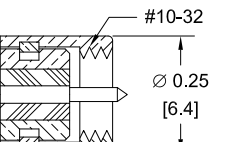
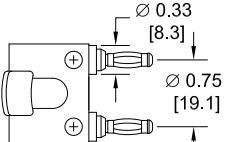
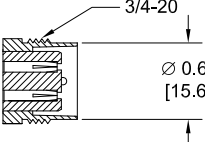
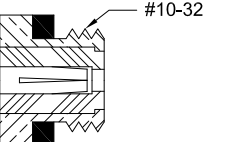
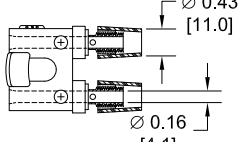
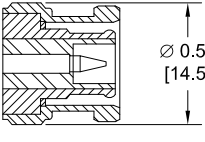
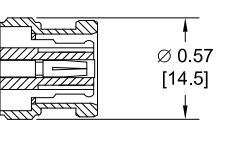
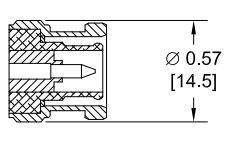
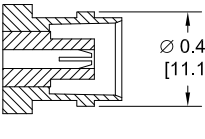
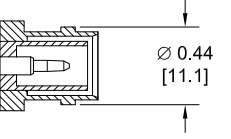
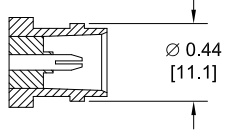









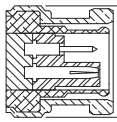
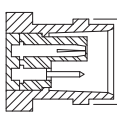
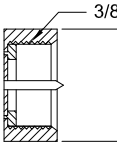
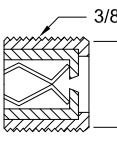
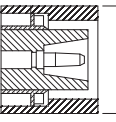
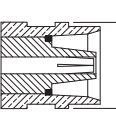
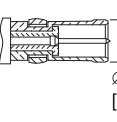
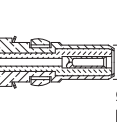
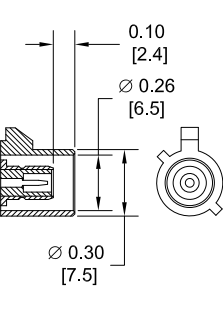
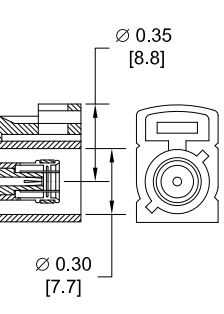





1.0/2.3 SLIDE ON	PLUG		1.0/2.3 SNAP ON	PLUG		1.6/56	PLUG	
	JACK			JACK			JACK	
1.85 mm**	MALE		2.4 mm**	MALE		2.92 mm**	MALE	
	FEMALE			FEMALE			FEMALE	
3.5 mm*	MALE		7 mm	MALE		7/16	PLUG	
	FEMALE			FEMALE			JACK	
3/4-20 TWINAX	MALE		10-32	MALE		BANANA	PLUG	
	FEMALE			FEMALE			JACK	
BNC	MALE		REVERSE POLARITY BNC	MALE		75 OHM BNC	MALE	
	FEMALE			FEMALE			FEMALE	

*SMA, 2.92mm, & 3.5mm CONNECTORS WILL MATE MECHANICALLY & ELECTRICALLY TO EACH OTHER.

**1.85mm & 2.4mm CONNECTORS WILL MATE MECHANICALLY & ELECTRICALLY TO EACH OTHER.

CONNECTOR IDENTIFIER

SPECIFICATIONS SHOWN ARE INTENDED FOR IDENTIFICATION PURPOSES ONLY

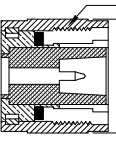
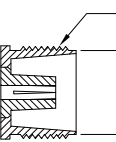
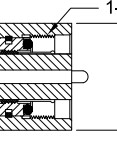
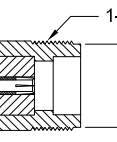
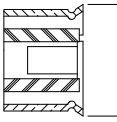
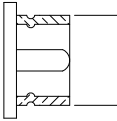
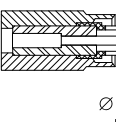
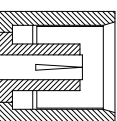
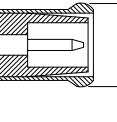
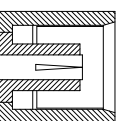
BNC TWINAX	PLUG	 Ø 0.57" [14.5mm]				
	JACK	 Ø 0.44" [11.1mm]				
F	MALE	 3/8-32 7/16 HEX				
	FEMALE	 3/8-32 Ø 0.34 [8.5]				
C	MALE	 Ø 0.75" [19.1mm]				
	FEMALE	 Ø 0.60" [15.2mm]				
D SUBMINIATURE	PLUG	 Ø 0.19" [4.8mm]				
	RECEPTACLE	 Ø 0.15" [3.9mm]				
FAKRA	PLUG	 0.10 [2.4] Ø 0.26 [6.5] Ø 0.30 [7.5]				
	JACK	 Ø 0.35 [8.8] Ø 0.30 [7.7]				
FAKRA	COMPLETE KEY CODE INFO	CODE	JACK	PLUG	COLOR	APPLICATION
		A			BLACK	RADIO WITH PHANTOM SUPPLY
		B			WHITE	RADIO WITHOUT PHANTOM SUPPLY
		C			BLUE	GPS: TELEMATICS OR NAVIGATION
		D			BORDEAUX	GSM: CELLULAR PHONE
H			VIOLET	GPS: TELEMATICS AND NAVIGATION		
I			BEIGE	BLUETOOTH		
K			CURRY	RADIO WITH I.F. OUTPUT (ANTENNA DIVERSITY)		
Z			WATER BLUE	NEUTRAL CODING		
GR874	MALE	 3/4-20 Ø 0.90 [22.9]				
	FEMALE	 3/4-20 Ø 0.67 [17.1]				
LC	MALE	 1-1/4-18 1-1/2 HEX				
	FEMALE	 1-1/4-18 Ø 1.17 [29.6]				
UMCX	PLUG	 Ø 0.10 [2.5]				
	JACK	 Ø 0.08 [2.0]				
MC-CARD	PLUG	 Ø 0.087 [2.2]				
	JACK	 Ø 0.20 [5.0]				
MCX	PLUG	 Ø 0.15 [3.7]				
	JACK	 Ø 0.20 [5.0]				

CONNECTOR IDENTIFIER

SPECIFICATIONS SHOWN ARE INTENDED FOR IDENTIFICATION PURPOSES ONLY

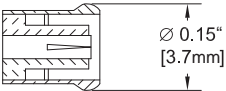
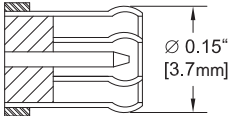
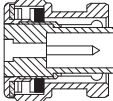
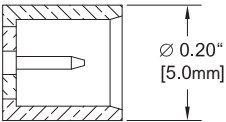
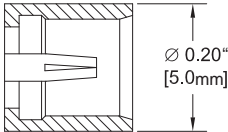
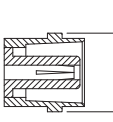
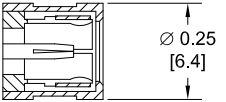
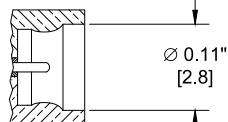
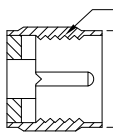
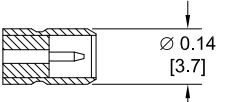
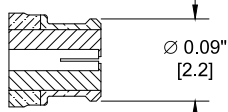
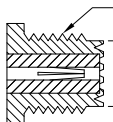
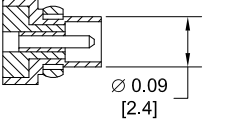
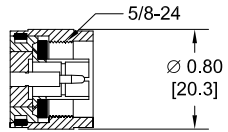
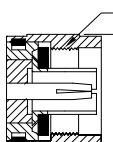
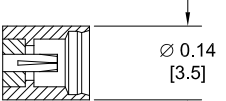
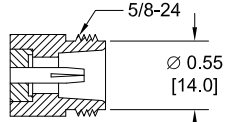
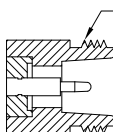
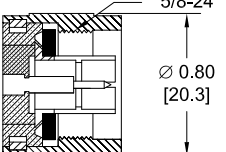
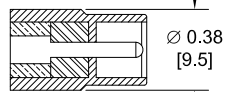
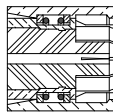
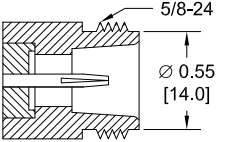
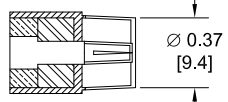
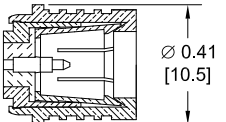
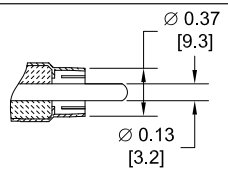
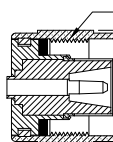
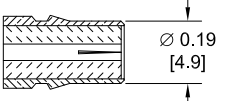
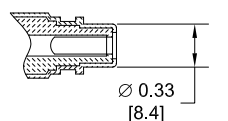
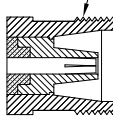
REVERSE POLARITY MCX	PLUG	 Ø 0.15" [3.7mm]	75 OHM MCX	PLUG	 Ø 0.15" [3.7mm]	MHV	MALE	 Ø 0.57" [14.5mm]
	JACK	 Ø 0.20" [5.0mm]		JACK	 Ø 0.20" [5.0mm]		FEMALE	 Ø 0.44" [11.1mm]
MINI 75 OHM SMB	PLUG	 Ø 0.25 [6.4]	MINI SMP	MALE	 Ø 0.11" [2.8]	MINI-UHF	MALE	 3/8-24 Ø 0.45 [11.5]
	JACK	 Ø 0.14 [3.7]		FEMALE	 Ø 0.09" [2.2]		FEMALE	 3/8-24 Ø 0.31 [7.8]
MMCX	PLUG	 Ø 0.09 [2.4]	N	MALE	 5/8-24 Ø 0.80 [20.3]	REVERSE POLARITY N	MALE	 5/8-24 Ø 0.80 [20.3]
	JACK	 Ø 0.14 [3.5]		FEMALE	 5/8-24 Ø 0.55 [14.0]		FEMALE	 5/8-24 Ø 0.55 [14.0]
75 OHM N	MALE	 5/8-24 Ø 0.80 [20.3]	PAL	PLUG	 Ø 0.38 [9.5]	POSITIVE SNAP	 Ø 0.39 [9.9]	
	FEMALE	 5/8-24 Ø 0.55 [14.0]		JACK	 Ø 0.37 [9.4]			
OMA	MALE	 Ø 0.41 [10.5]	RCA	PLUG	 Ø 0.37 [9.3] Ø 0.13 [3.2]	SC	MALE	 11/16-24 Ø 0.80 [20.3]
	FEMALE	 Ø 0.19 [4.9]		JACK	 Ø 0.33 [8.4]		FEMALE	 11/16-24 Ø 0.63 [15.9]

CONNECTOR IDENTIFIER

SPECIFICATIONS SHOWN ARE INTENDED FOR IDENTIFICATION PURPOSES ONLY

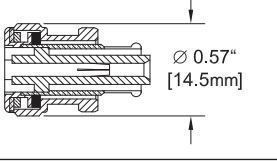
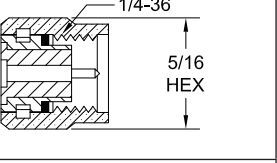
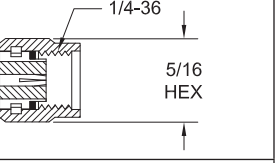
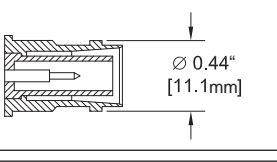
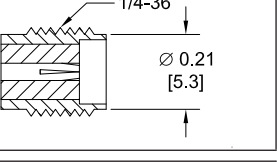
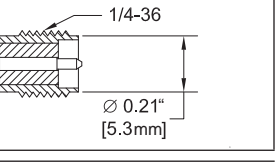
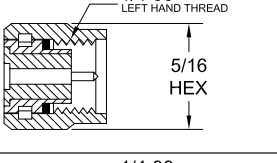
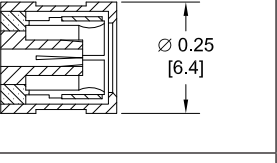
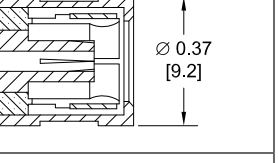
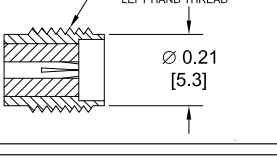
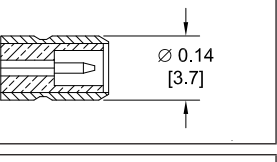
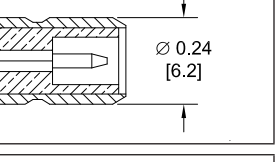
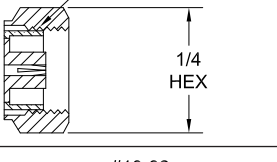
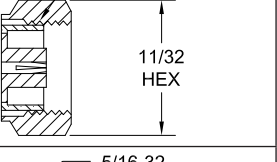
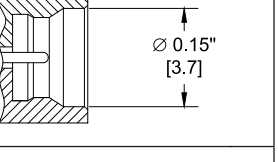
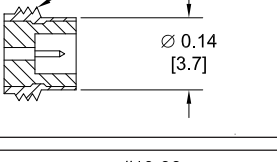
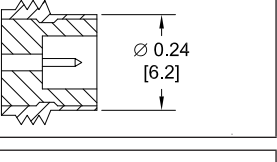
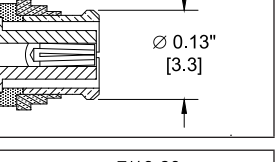
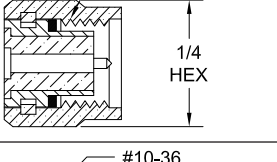
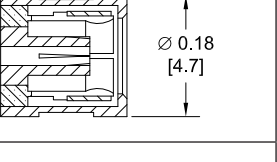
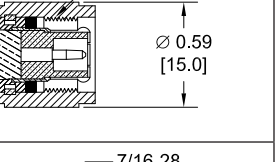
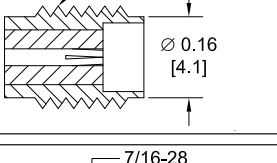
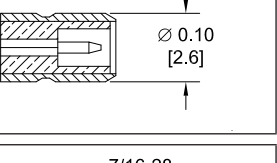
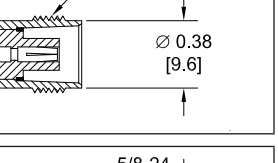
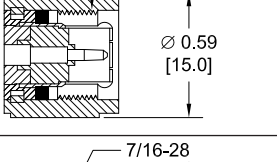
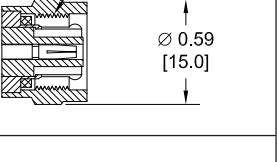
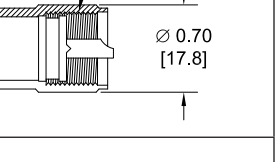
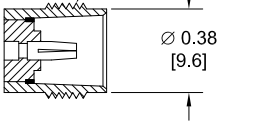
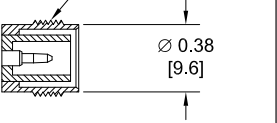
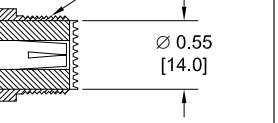
SHV	PLUG	 Ø 0.57" [14.5mm]	SMA*	MALE	 1/4-36 5/16 HEX	REVERSE POLARITY SMA	MALE	 1/4-36 5/16 HEX
	JACK	 Ø 0.44" [11.1mm]		FEMALE	 1/4-36 Ø 0.21 [5.3]		FEMALE	 1/4-36 Ø 0.21" [5.3mm]
SMA REVERSE THREAD	MALE	 1/4-36 LEFT HAND THREAD 5/16 HEX	SMB	PLUG	 Ø 0.25 [6.4]	75 OHM SMB	PLUG	 Ø 0.37 [9.2]
	FEMALE	 1/4-36 LEFT HAND THREAD Ø 0.21 [5.3]		JACK	 Ø 0.14 [3.7]		JACK	 Ø 0.24 [6.2]
SMC	PLUG	 #10-32 1/4 HEX	75 OHM SMC	PLUG	 5/16-32 11/32 HEX	SMP	MALE	 Ø 0.15" [3.7]
	JACK	 #10-32 Ø 0.14 [3.7]		JACK	 5/16-32 Ø 0.24 [6.2]		FEMALE	 Ø 0.13" [3.3]
SSMA	MALE	 #10-36 1/4 HEX	SSMB	PLUG	 Ø 0.18 [4.7]	TNC	MALE	 7/16-28 Ø 0.59 [15.0]
	FEMALE	 #10-36 Ø 0.16 [4.1]		JACK	 Ø 0.10 [2.6]		FEMALE	 7/16-28 Ø 0.38 [9.6]
75 OHM TNC	MALE	 7/16-28 Ø 0.59 [15.0]	REVERSE POLARITY TNC	MALE	 7/16-28 Ø 0.59 [15.0]	UHF	MALE	 5/8-24 Ø 0.70 [17.8]
	FEMALE	 7/16-28 Ø 0.38 [9.6]		FEMALE	 7/16-28 Ø 0.38 [9.6]		FEMALE	 5/8-24 Ø 0.55 [14.0]

*SMA, 2.92mm & 3.5mm CONNECTORS WILL MATE MECHANICALLY & ELECTRICALLY TO EACH OTHER.



Free Shipping Available
via UPS Ground to
USA & Canada



Technical
Support
(866) 727-8376



Same-Day Shipping,
Even Custom
Cable Assemblies

CONNECTOR FREQUENCY RANGE CHART

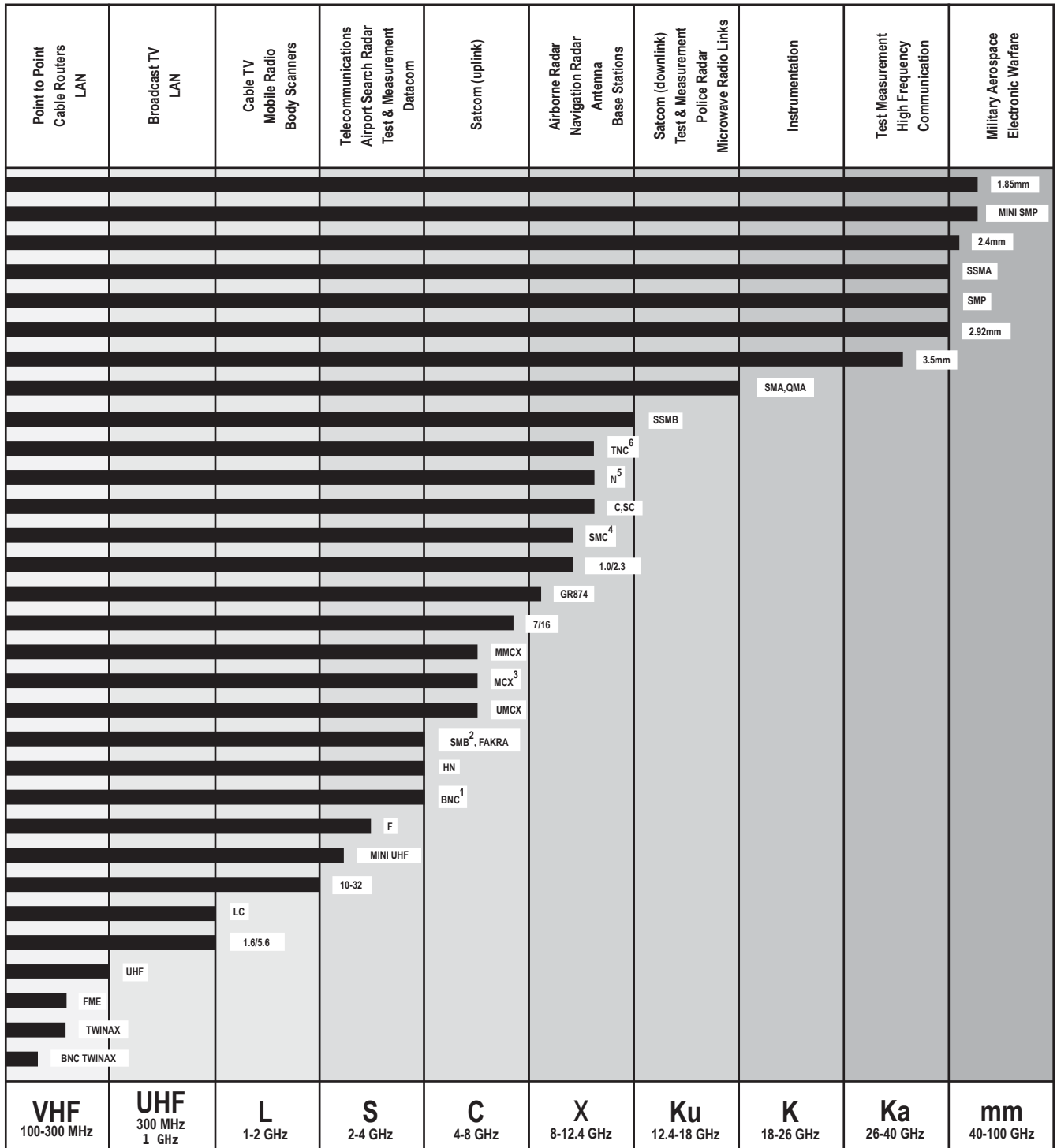

Notes:

- 1: BNC-75 Ohm connectors operate up to 1 GHz
- 2: SMB-75 Ohm & Mini SMB-75 Ohm connectors operate up to 4 GHz
- 3: MCX-75 Ohm connectors operate up to 6 GHz
- 4: SMC-75 Ohm connectors operate up to 10 GHz
- 5: N-75 Ohm connectors operate up to 1.5 GHz
- 6: TNC-75 Ohm connectors operate up to 1 GHz



Australian Representatives
ROJONE, PTY LTD.
 Tel: 02 9829 1555
 E: sales@rojone.com.au
 www.rojone.com.au