

PAGE 1/2	ISSUE 07-12-16J	SERIES ADAPT	PART NUMBER R191315000
----------	-----------------	--------------	------------------------

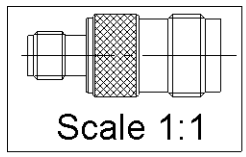

All dimensions are in mm.

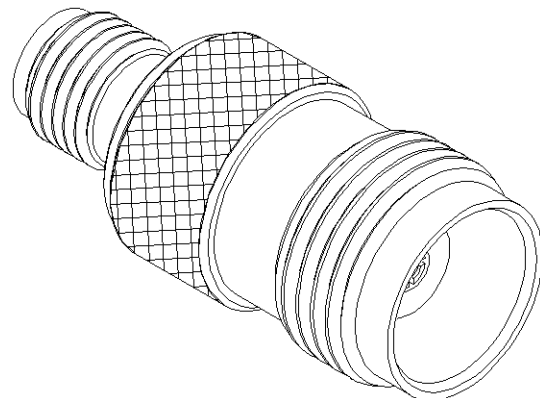
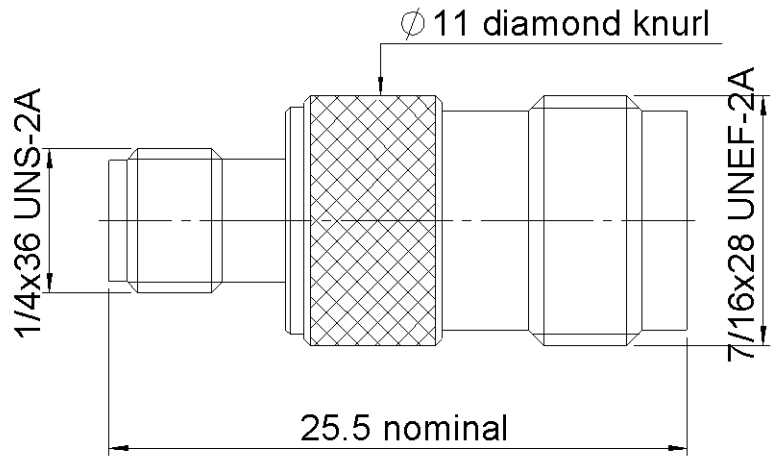
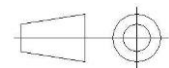

COMPONENTS	MATERIALS	PLATING (µm)
Body	BRASS.	NICKEL .
Center contact	BERYLLIUM COPPER	GOLD OVER NICKEL
Outer contact	-	-
Insulator	PTFE	-
Gasket	-	-
Others parts	BERYLLIUM COPPER	NICKEL .
-	-	-
-	-	-

PAGE 2/2	ISSUE 07-12-16J	SERIES ADAPT	PART NUMBER R191315000
-----------------	------------------------	---------------------	-------------------------------

PACKAGING

Standard	Unit	Other
1	-	Contact us

ELECTRICAL CHARACTERISTICS

Impedance		50	Ω
Frequency		0-11	GHz
VSWR	1.05	+	0,0250 x F(GHz) Maxi
Insertion loss		0.06	\sqrt{F} (GHz) dB Maxi
RF leakage	-	(60 - F(GHz) dB Maxi
Voltage rating		335	Veff Maxi
Dielectric withstanding voltage		1000	Veff mini
Insulation resistance		5000	M Ω mini

ENVIRONMENTAL

Operating	-65/+125	$^{\circ}\text{C}$
Hermetic seal	NA	Atm.cm3/s
Panel leakage	NA	

MECHANICAL CHARACTERISTICS

Center contact retention			
Axial force – Mating End		*18	N mini
Axial force – Opposite end		*18	N mini
Torque		NA	N.cm mini

SPECIFICATION

Recommended torque			
Mating	SMA	0	N.cm
	TNC	0	N.cm
	-	0	N.cm
Panel nut		NA	N.cm

OTHER CHARACTERISTICS

*out of SMA CDC

Mating life	500	Cycles mini
Weight	7,7000	g