



WR-90 Waveguide 30 dB Crossguide Coupler, 3 Port,
CPR-90G Flange, 8.2 GHz to 12.4 GHz, Bronze

Waveguide Couplers Assemblies Technical Data

PEWCT1025

The PEWCT1025 is a 30 dB three port, terminated WR-90 crossguide waveguide coupler that operates in the frequency range of 8.2 to 12.4 GHz. The coupler has a typical VSWR of 1.05. These designs are made of Bronze with Brass CPR-90G Flanges. Pasternack offers a complete family of crossguide couplers in both three port (terminated) and four port (unterminated) configurations that are in stock and ship on the same day. Top wall couplers are also available.

Features

- Three Port
- Crossguide Waveguide Coupler
- Terminated
- 30 dB Nominal Coupling Level
- 8.2 GHz to 12.4 GHz Frequency Range
- Waveguide Body made of Bronze with Brass Flanges
- Low VSWR
- Grooved CPR

Applications

- Test Benches
- Radar
- Satellite
- Microwave Radio
- Attenuation Measurements
- Power Measurements
- Source Leveling

Electrical Specifications

Description	Minimum	Typical	Maximum	Units
Frequency Range	8.2		12.4	GHz
Coupler				
Nominal Coupling Level		30		dB
Directivity		20		dB
Insertion Loss		0.1		dB
Main Line VSWR		1.05:1		
Termination				
VSWR		1.02		
Input Power (CW)			4	Watts

Mechanical Specifications

Size

Length 6.5 in [165.1 mm]
Width 3 in [76.2 mm]

Interface

Waveguide Size WR-90
Flange Type CPR-90G

Click the following link (or enter part number in "SEARCH" on website) to obtain additional part information including price, inventory and certifications: [WR-90 Waveguide 30 dB Crossguide Coupler, 3 Port, CPR-90G Flange, 8.2 GHz to 12.4 GHz, Bronze PEWCT1025](#)



WR-90 Waveguide 30 dB Crossguide Coupler, 3 Port,
CPR-90G Flange, 8.2 GHz to 12.4 GHz, Bronze

Waveguide Couplers Assemblies Technical Data

PEWCT1025

Flange Material and Plating	Brass
Coupler Body Material and Plating	Bronze
Termination Body Material and Plating	Bronze

Environmental Specifications

Compliance Certifications (see [product page](#) for current document)

Plotted and Other Data

Notes:

Typical Performance Data

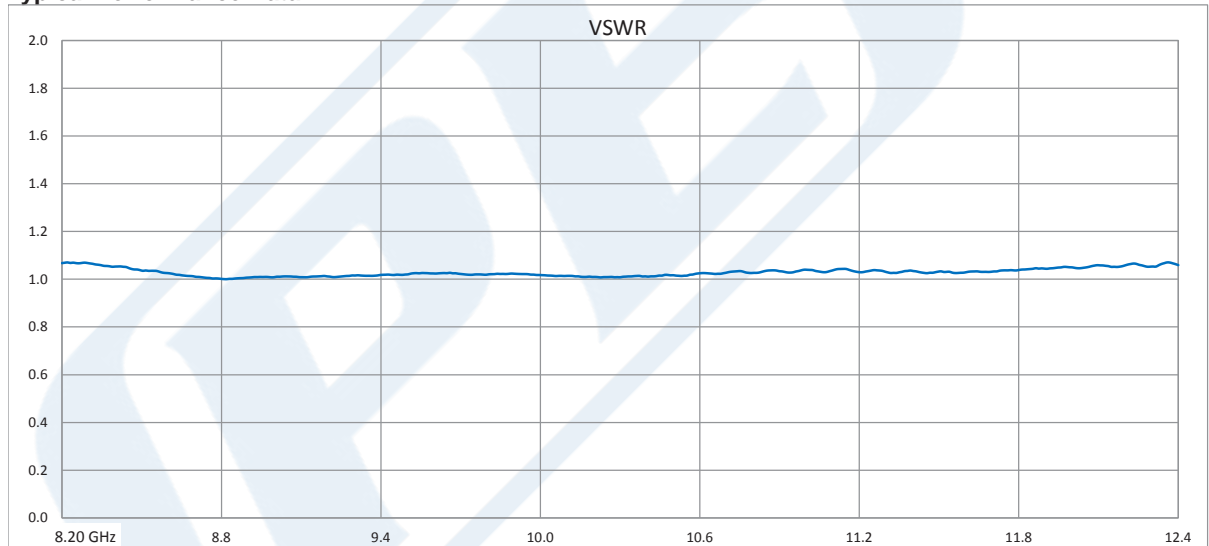

Click the following link (or enter part number in "SEARCH" on website) to obtain additional part information including price, inventory and certifications: [WR-90 Waveguide 30 dB Crossguide Coupler, 3 Port, CPR-90G Flange, 8.2 GHz to 12.4 GHz, Bronze PEWCT1025](#)



WR-90 Waveguide 30 dB Crossguide Coupler, 3 Port,
CPR-90G Flange, 8.2 GHz to 12.4 GHz, Bronze

Waveguide Couplers Assemblies Technical Data

PEWCT1025

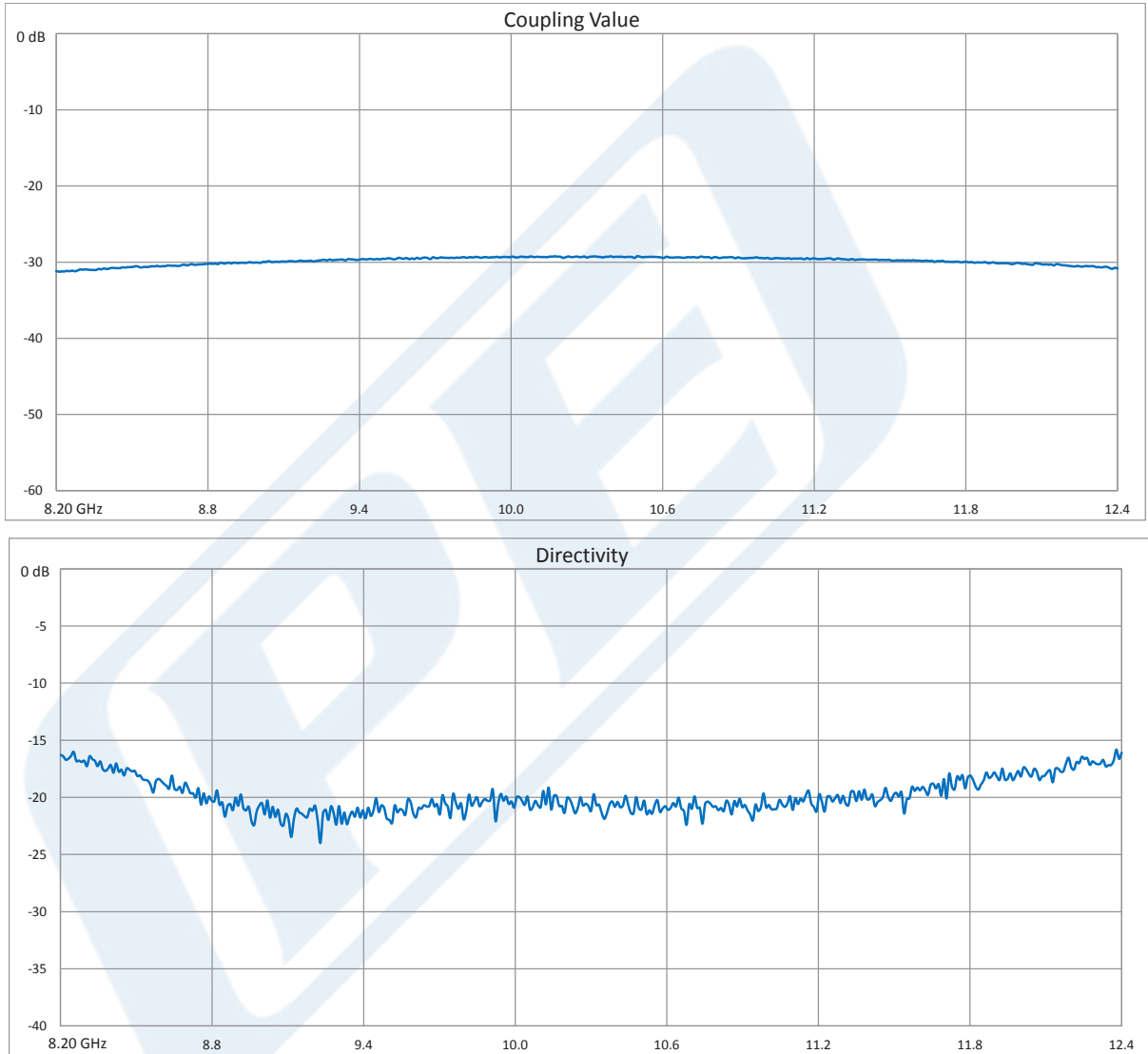

Click the following link (or enter part number in "SEARCH" on website) to obtain additional part information including price, inventory and certifications: [WR-90 Waveguide 30 dB Crossguide Coupler, 3 Port, CPR-90G Flange, 8.2 GHz to 12.4 GHz, Bronze PEWCT1025](#)



WR-90 Waveguide 30 dB Crossguide Coupler, 3 Port,
CPR-90G Flange, 8.2 GHz to 12.4 GHz, Bronze

Waveguide Couplers Assemblies Technical Data

PEWCT1025

WR-90 Waveguide 30 dB Crossguide Coupler, 3 Port, CPR-90G Flange, 8.2 GHz to 12.4 GHz, Bronze from Pasternack Enterprises has same day shipment for domestic and International orders. Our RF, microwave and millimeter wave products maintain a 99.4% availability and are part of the broadest selection in the industry.

Click the following link (or enter part number in "SEARCH" on website) to obtain additional part information including price, inventory and certifications: [WR-90 Waveguide 30 dB Crossguide Coupler, 3 Port, CPR-90G Flange, 8.2 GHz to 12.4 GHz, Bronze PEWCT1025](https://www.pasternack.com/wr-90-waveguide-30-db-crossguide-coupler-3-port-cpr-90g-pewct1025-p.aspx)

URL: <https://www.pasternack.com/wr-90-waveguide-30-db-crossguide-coupler-3-port-cpr-90g-pewct1025-p.aspx>

The information contained in this document is accurate to the best of our knowledge and representative of the part described herein. It may be necessary to make modifications to the part and/or the documentation of the part, in order to implement improvements. Pasternack reserves the right to make such changes as required. Unless otherwise stated, all specifications are nominal. Pasternack does not make any representation or warranty regarding the suitability of the part described herein for any particular purpose, and Pasternack does not assume any liability arising out of the use of any part or documentation.

PEWCT1025 CAD Drawing

WR-90 Waveguide 30 dB Crossguide Coupler, 3 Port, CPR-90G Flange, 8.2 GHz to 12.4 GHz, Bronze

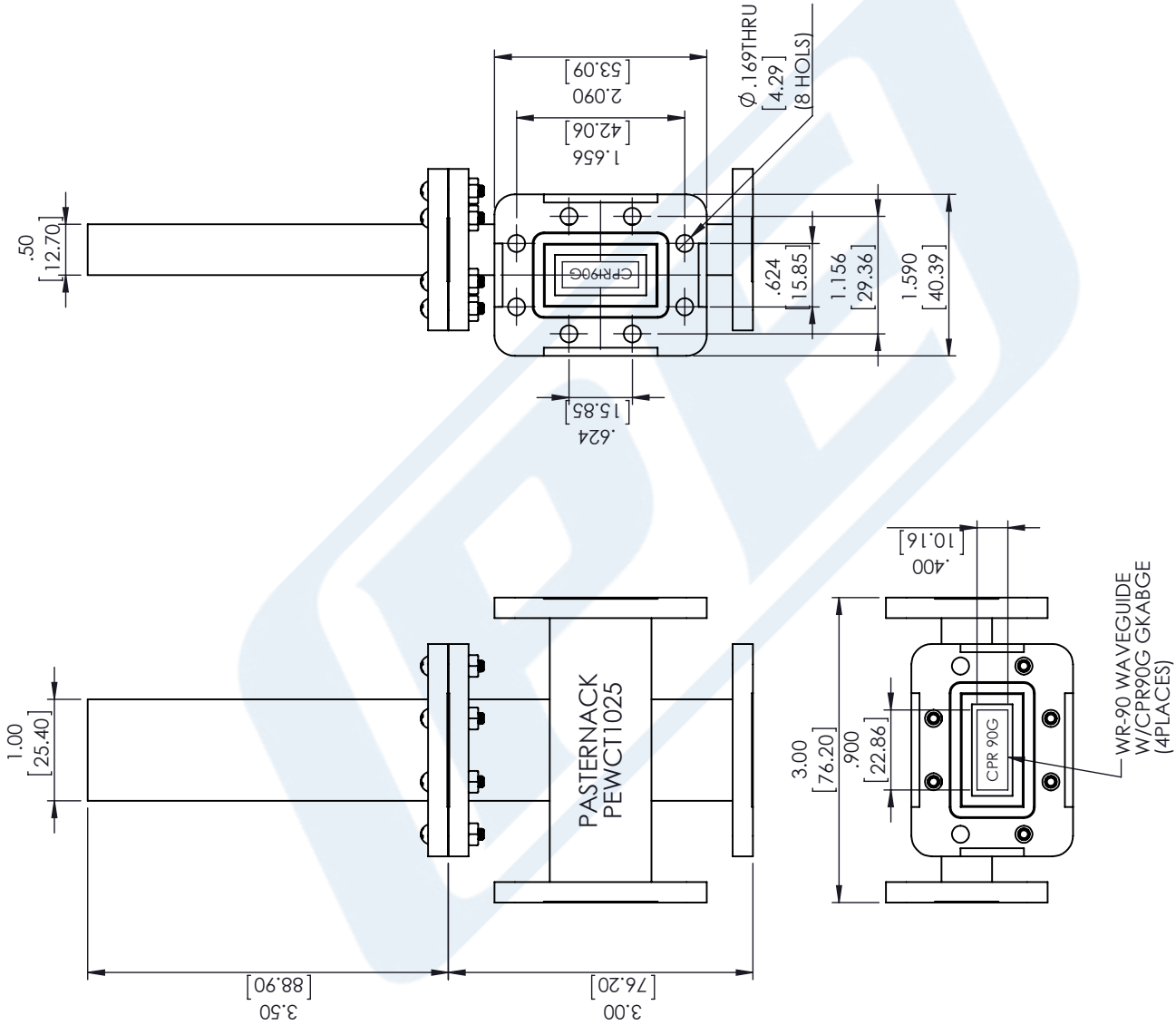

STANDARD TOLERANCES	
.X	±0.2
.XX	±0.01
.XXX	±0.005

*STANDARD TOLERANCES APPLY ONLY TO DIMENSIONS IN INCHES



Pasternack Enterprises, Inc.
 P.O. Box 16759 | Irvine | CA | 92623
 Phone: (949) 261-1920 | Fax: (949) 261-7451
 Website: www.pasternack.com | E-Mail: sales@pasternack.com

DWG TITLE

PEWCT1025

NOTES:
 1. UNLESS OTHERWISE SPECIFIED ALL DIMENSIONS ARE NOMINAL.
 2. ALL SPECIFICATIONS ARE SUBJECT TO CHANGE WITHOUT NOTICE AT ANY TIME
 3. DIMENSIONS ARE IN INCHES [mm].

CAGE CODE 53919

CAD FILE 050817

SCALE N/A

SIZE A

0157