



## WR-15 Instrumentation Grade Waveguide E-Bend with UG-385/U Flange Operating from 50 GHz to 75 GHz

### TECHNICAL DATA SHEET

PE-W15B001

Pasternack's instrumentation grade waveguide bends are constructed of a high quality oxygen free hard copper with high precision mechanical tolerances as tight as  $\pm 0.001$ " that ensures repeatable and consistent RF performance. Our commercial and instrumentation grade waveguide bends range in size from WR-12 to WR-137 and include grooved and non-grooved flanged designs. Pasternack waveguide bends are offered in E-Bend and H-Bend configurations, and each waveguide bend is labeled for easy identification. Our commercial grade waveguide bends are painted blue and our instrumentation grade versions are hard gold plated over a copper flash.

- WR-12 to WR-137 Waveguide Bends
- Grooved and Non-Grooved Flange Designs
- Available for frequency ranges between 5.8 GHz to 90 GHz
- Comprehensive waveguide offering also includes Waveguide Sections, Waveguide to Coax Adapters, Filters, Terminations, and more.
- High Precision Tolerance as Tight as  $\pm 0.001$ "

#### Electrical Specifications

Description	Minimum	Typical	Maximum	Units
Frequency Range	50		75	GHz
VSWR			1.1:1	
Insertion Loss		0.17		dB

#### Mechanical Specifications

Waveguide Size: WR-15  
 Waveguide Design: Instrumentation Grade

Description	Flange 1	Waveguide	Flange 2
Interface	UG-385/U	WR-15	UG-385/U
Material	Oxygen Free Hard Copper	Oxygen Free Hard Copper	Oxygen Free Hard Copper
Plating	Hard Gold over Copper Flash	Hard Gold over Copper Flash	Hard Gold over Copper Flash

#### Compliance Certifications (visit [www.Pasternack.com](http://www.Pasternack.com) for current document)

RoHS Compliant

Notes:

- Values at +25 °C, sea level

Click the following link (or enter part number in "SEARCH" on website) to obtain additional part information including price, inventory and certifications: [WR-15 Instrumentation Grade Waveguide E-Bend with UG-385/U Flange Operating from 50 GHz to 75 GHz PE-W15B001](#)



WR-15 Instrumentation Grade Waveguide E-Bend with  
UG-385/U Flange Operating from 50 GHz to 75 GHz

TECHNICAL DATA SHEET

PE-W15B001

Power Data

Outline Drawing

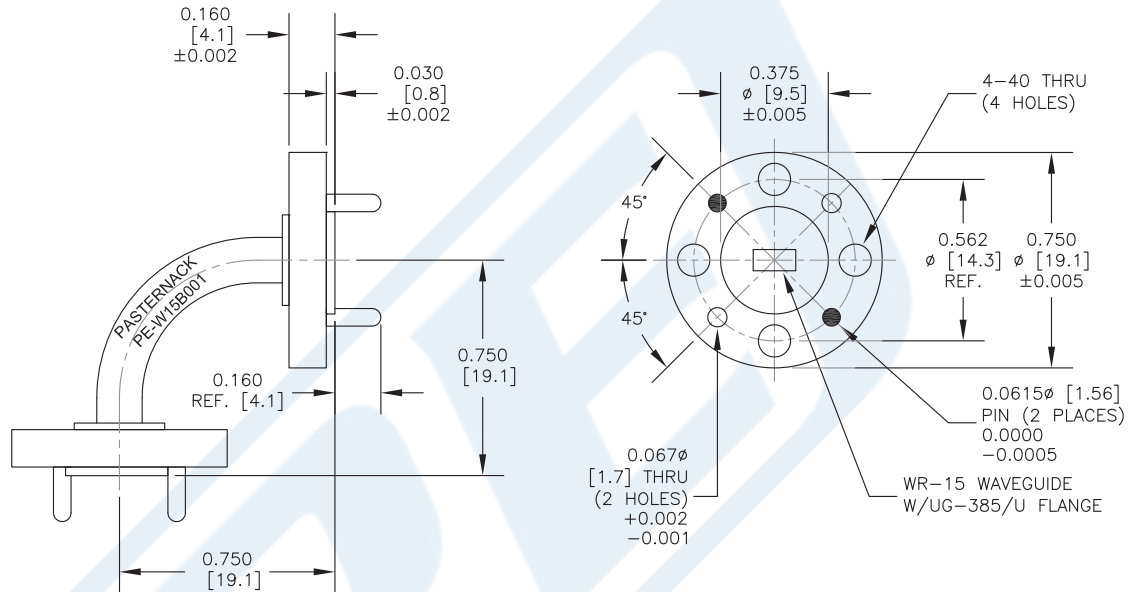

WR-15 Instrumentation Grade Waveguide E-Bend with UG-385/U Flange Operating from 50 GHz to 75 GHz from Pasternack Enterprises has same day shipment for domestic and International orders. Our RF, microwave and millimeter wave products maintain a 99% availability and are part of the broadest selection in the industry.

Click the following link (or enter part number in "SEARCH" on website) to obtain additional part information including price, inventory and certifications: [WR-15 Instrumentation Grade Waveguide E-Bend with UG-385/U Flange Operating from 50 GHz to 75 GHz PE-W15B001](http://www.pasternack.com/wr-15-waveguide-e-bend-ug-385-flange-50-75-ghz-pe-w15b001-p.aspx)

URL: <http://www.pasternack.com/wr-15-waveguide-e-bend-ug-385-flange-50-75-ghz-pe-w15b001-p.aspx>

The information contained in this document is accurate to the best of our knowledge and representative of the part described herein. It may be necessary to make modifications to the part and/or the documentation of the part, in order to implement improvements. Pasternack reserves the right to make such changes as required. Unless otherwise stated, all specifications are nominal. Pasternack does not make any representation or warranty regarding the suitability of the part described herein for any particular purpose, and Pasternack does not assume any liability arising out of the use of any part or documentation.